

TravelMate 610

Service Guide

Service guide files and updates are available on the AIPG/CSD web; for more information, please refer to <http://csd.acer.com.tw>

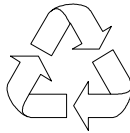

100% Recycled Paper

PART NO.: 49.41Q04.001
DOC. NO.: SG363-0103A

PRINTED IN TAIWAN

Revision History

Please refer to the table below for the updates made on TravelMate 610 service guide.

Date	Chapter	Updates
04/172001	Chapter 1	Change video memory "Up to 11MB SDRAM (4MB dedicated display cache combined with Intel(R) DVMT)"

Copyright

Copyright © 1999 by Acer Incorporated. All rights reserved. No part of this publication may be reproduced, transmitted, transcribed, stored in a retrieval system, or translated into any language or computer language, in any form or by any means, electronic, mechanical, magnetic, optical, chemical, manual or otherwise, without the prior written permission of Acer Incorporated.

Disclaimer

The information in this guide is subject to change without notice.

Acer Incorporated makes no representations or warranties, either expressed or implied, with respect to the contents hereof and specifically disclaims any warranties of merchantability or fitness for any particular purpose. Any Acer Incorporated software described in this manual is sold or licensed "as is". Should the programs prove defective following their purchase, the buyer (and not Acer Incorporated, its distributor, or its dealer) assumes the entire cost of all necessary servicing, repair, and any incidental or consequential damages resulting from any defect in the software.

Acer is a registered trademark of Acer Corporation.

Intel is a registered trademark of Intel Corporation.

Pentium and Pentium II/III are trademarks of Intel Corporation.

Other brand and product names are trademarks and/or registered trademarks of their respective holders.

Conventions

The following conventions are used in this manual:

Screen messages	Denotes actual messages that appear on screen.
NOTE	Gives bits and pieces of additional information related to the current topic.
WARNING	Alerts you to any damage that might result from doing or not doing specific actions.
CAUTION	Gives precautionary measures to avoid possible hardware or software problems.
IMPORTANT	Reminds you to do specific actions relevant to the accomplishment of procedures.

Preface

Before using this information and the product it supports, please read the following general information.

1. This Service Guide provides you with all technical information relating to the BASIC CONFIGURATION decided for Acer's "global" product offering. To better fit local market requirements and enhance product competitiveness, your regional office MAY have decided to extend the functionality of a machine (e.g. add-on card, modem, or extra memory capability). These LOCALIZED FEATURES will NOT be covered in this generic service guide. In such cases, please contact your regional offices or the responsible personnel/channel to provide you with further technical details.
2. Please note WHEN ORDERING FRU PARTS, that you should check the most up-to-date information available on your regional web or channel. If, for whatever reason, a part number change is made, it will not be noted in the printed Service Guide. For ACER-AUTHORIZED SERVICE PROVIDERS, your Acer office may have a DIFFERENT part number code to those given in the FRU list of this printed Service Guide. You MUST use the list provided by your regional Acer office to order FRU parts for repair and service of customer machines.

Chapter 1	System Specifications	1
	Features1
	System Block Diagram3
	Board Layout4
	Top View4
	Bottom View5
	Panel6
	Front Panel6
	Left Panel7
	Right Panel8
	Rear Panel9
	Bottom Panel10
	Indicators11
	Keyboard12
	Special keys12
	Hardware Specifications and Configurations16
 Chapter 2	 System Utilities	 29
	BIOS Setup Utility29
	Navigating the BIOS Utility29
	System Information30
	Basic System Settings31
	Startup Configuration32
	IDE Primary Master33
	IDE Secondary Master33
	Onboard Devices Configuration34
	PCI IRQ Routing35
	System Security36
	Boot Options37
	Exit Setup38
	BIOS Flash Utility39
	Executing Flash Program39
	System Utility Diskette40
	Read Panel ID Setting40
	Write Panel ID Setting40
	Thermal and Fan Utility40
	Main Board Data Utility40
	System Diagnostic Diskette42
	PQA System Diagnostics42
	Audio Test42
	USB Test43
	Smart Card Test43
	Infrared Ray (IR) Test43
	Running PQA Diagnostics Program43
 Chapter 3	 Machine Disassembly and Replacement	 47
	General Information48
	Before You Begin48
	Disassembly Procedure Flowchart49
	Removing the Battery Pack51
	Removing the Hard disk drive Module52
	Disassembling the Hard disk drive Module52
	Removing the CD-ROM Drive Module54

Table of Contents

Disassembling the CD-ROM drive Module	54
Removing the Extended Memory	55
Removing the Modem Board	56
Disassembling the LCD	57
Removing the Middle Cover	57
Removing the Keyboard	58
Removing the LCD Module	59
Removing LCD Bezel	60
Removing the Inverter/LED Board	60
Removing the LCD	61
Removing the LCD Hinges	62
Disassembling the Upper Case	64
Removing the RTC Battery	64
Removing the LAN Board	64
Removing the Upper Case	65
Disassembling the Lower Case	66
Removing the Smart Card Bracket	66
Removing the HDD Transfer Board	66
Removing the Microphone	67
Removing the Speakers	68
Removing the Front Panel	68
Removing the Fan	69
Removing the CPU	70
Removing the Thermal Charger Bracket	70
Removing the Main board	71
Removing the Antenna Boards	71
Removing the Touch Pad	72
Chapter 4 Troubleshooting	75
System Check Procedures	76
External Diskette Drive Check	76
External CD/DVD-ROM Drive Check	76
Keyboard or Auxiliary Input Device Check	76
Memory Check	77
Power System Check	77
Touchpad Check	78
Power-On Self-Test (POST) Error Message	79
Index of Error Messages	80
Index of Symptom-to-FRU Error Message	82
Intermittent Problems	86
Undetermined Problems	86
Index of AFlash BIOS Error Message	87
Index of PQA Diagnostic Error Code, Message	87
Mainboard Top Vie	89
Chapter 5 Jumper and Connector Information	89
Mainboard Bottom View	91
Hard Disk Transfer Board Top view	92
Hard Disk Transfer Board Bottom view	93
Chapter 6 FRU (Field Replaceable Unit) List	95
Appendix A Model Definition and Configuration	107
Appendix B Test Compatible Components	109
Microsoft Windows 98 SE Environment Test	110

Table of Contents

Microsoft Windows 2000 Environment Test	112
Windows ME Environment Test	115
Appendix C Online Support Information	119
Index	121

Table of Contents

System Specifications

Features

This computer was designed with the user in mind. Here are just a few of its many features:

Performance

- Intel Coppermine/Pentium® III processor featuring Intel® SpeedStep™ technology
- Integrated 256 KB level 2 cache
- 64-bit memory bus
- Removable high-capacity, Enhanced-IDE hard disk
- Removable optical drive (CD-RW or DVD-ROM is standard)
- External USB floppy drive
- Li-Ion battery pack
- Power management system with ACPI (Advanced Configuration Power Interface) control
- Smart Card Interface with pre-boot authentication systems as security feature

Display

- 14.1"Thin-Film Transistor (TFT) liquid-crystal display (LCD) displaying 24-bit true-color at 1024x768 eXtended Graphics Array (XGA) resolution
- Up to 11MB SDRAM (4MB dedicated display cache combined with Intel® DVMT²)
- Simultaneous LCD and CRT display support
- Supports other output display devices such as LCD projection panels for large-audience presentations
- "Automatic LCD dim" feature that automatically decides the best settings for your display and conserves power

Multimedia

- 16-bit high-fidelity PCI stereo audio with wavetable synthesizer
- Built-in speakers and microphone
- Optical drive
- USB video capture kit option

Connectivity

- High-speed V.90 56Kbps fax/data PCI modem port
- Fast infrared wireless communication
- Dual USB (Universal Serial Bus) ports
- Ethernet/Fast Ethernet port
- Optional Bluetooth wireless communication feature
- Optional 802.11b wireless LAN feature

Human-centric Design and Ergonomics

- Sleek, smooth and stylish design
- Full-sized keyboard
- Ergonomically-centered touchpad pointing device with scroll function
- Internet scroll key

Expansion

- One Type II CardBus PC Card (formerly PCMCIA) slot
- One SmartBus slot
- Upgradeable memory
- Removable drives (hard disk and optical drive)
- EasyPort port replicator

System Block Diagram

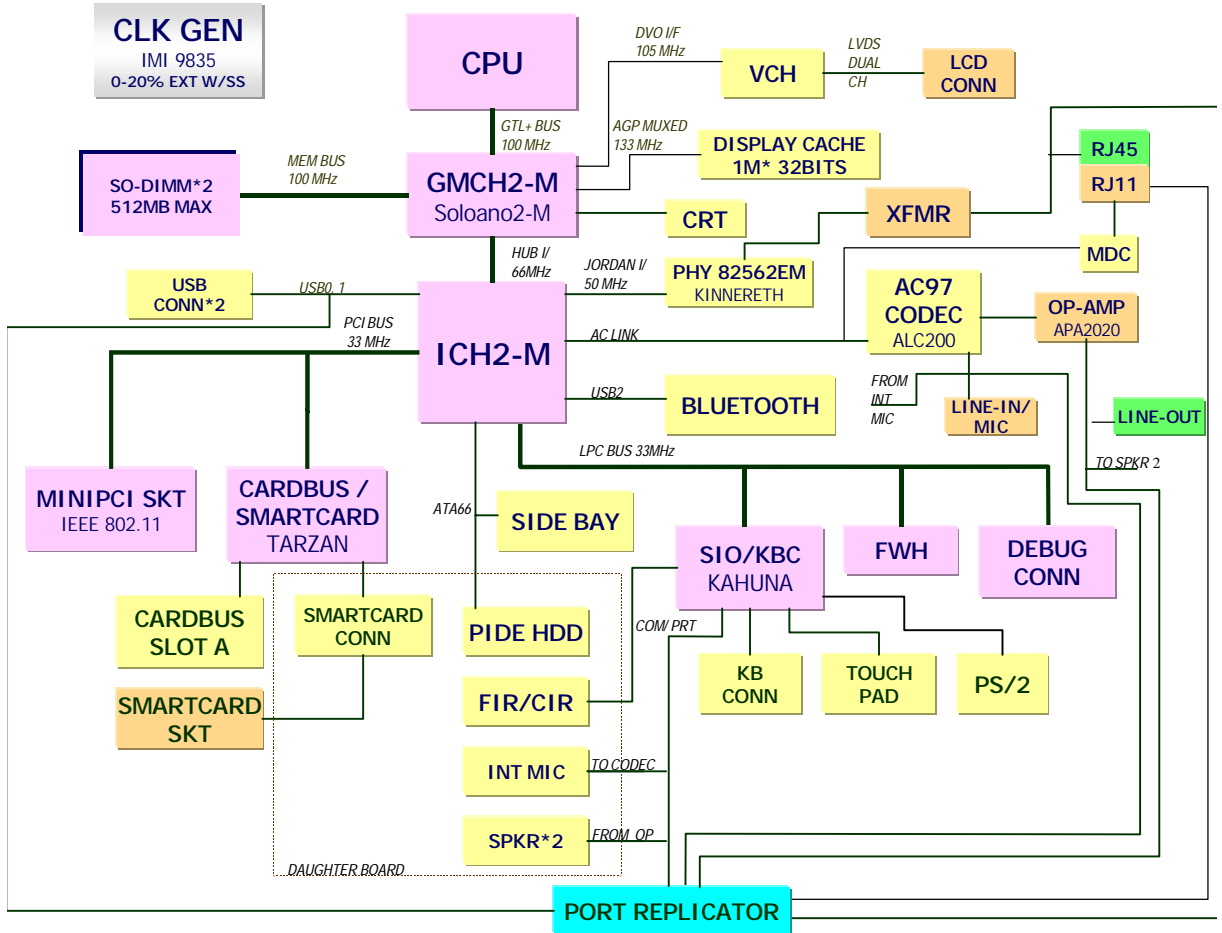

Board Layout

Top View

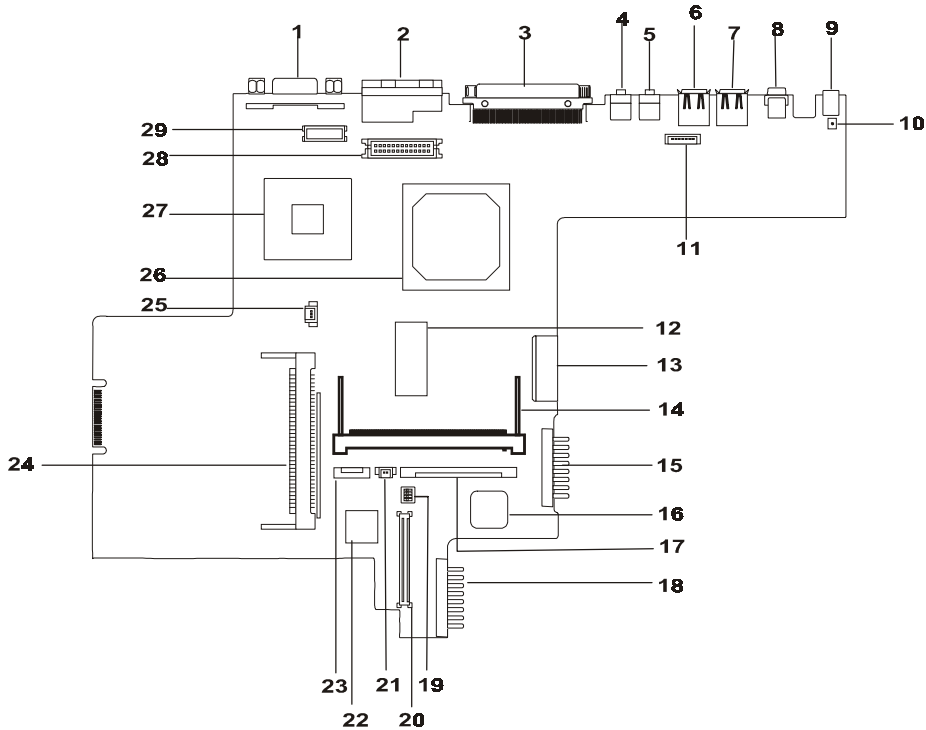

No.	Item	Description	No.	Item	Description
1	CN5	Video Port	16	U27	KBC/Super I/O
2	JK1	LAN/Modem Connecto	17	CN19	Internal Keyboard Connector
3	CN6	Port Replicator	18	CN22	Primary Battery Connecto
4	CN3	Line-out port	19	SW2	Mainboard Setting
5	CN4	Line-in/ MIC-in port	20	CN21	HDD Board Connector
6	CN7	USB 0 Port	21	CN18	RTC Battery Connector
7	CN8	USB 1 Port	22	UB3	BIOS ROM
8	CN2	PS/2 Port	23	CN30	Touchpad Connector
9	CN1	AC Adapter Connector	24	CN16	PCMCIA Socket
10	SW1	Cover Switch	25	CN12	FAN Connector
11	CN10	BlueTooth Connecto	26	U15	North Bridge (GMCH2M
12	U24	Display Cache	27	U14	CPU Socket
13	CN13	Bay Connector	28	CN11	LED/Inverter Board Connector
14	CN14	Mini PCI Card Connector	29	CN9	LCD Connector
15	CN17	Secondary Battery Connector			

Bottom View

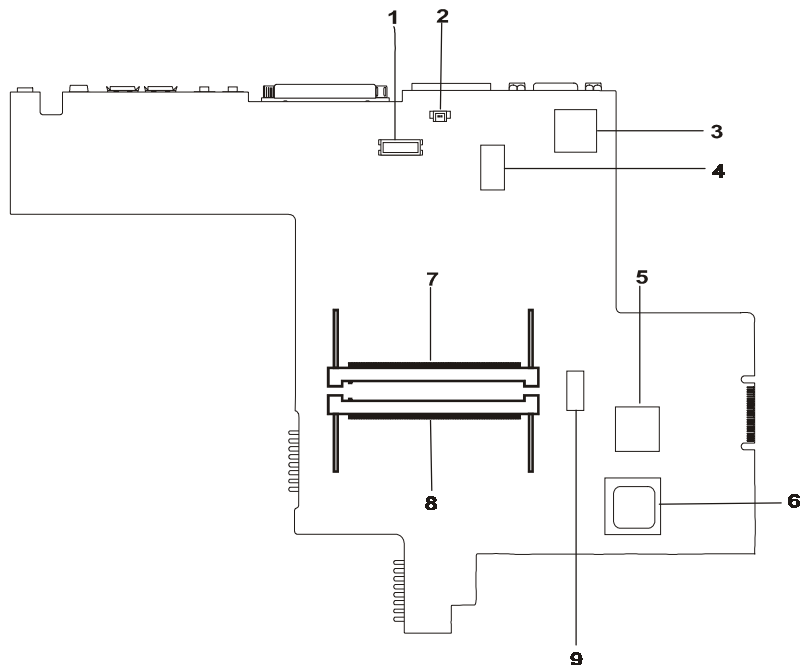



No.	Item	Description	No.	Item	Description
1	CN24	Modem Board Connector	6	U64	South Bridge
2	CN23	Modem Cable Connector	7	DM1	DIMM Socket 1
3	U36	VCH Controller	8	DM2	DIMM Socket 2
4	U53	LAN Controller	9	U57	Clock Generator Controller
5	U59	Card Bus Controller			

Panel

Ports allow you to connect peripheral devices to your computer as you would with a desktop PC.

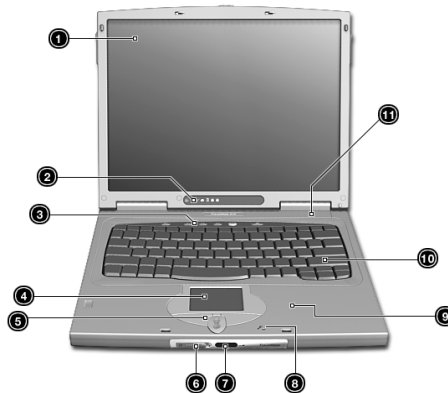
Front Panel



#	Icon	Item/ Port	Description
1		Display screen	Also called LCD (liquid-crystal display), displays computer output.
2		Status indicators	LEDs (light-emitting diodes) that turn on and off to show th status of the computer and its functions and components.
3		Launch keys	Buttons for launching frequently used programs.
4		Touchpad	Touch-sensitive pointing device which functions like a computer mouse.
5		Click buttons (left, center and right)	The left and right buttons function like the left and right mouse buttons; the center button serves as a scroll up/ down button.
6		Power switch	Turns on the computer power.
7		Infrared port	Interfaces with infrared devices (e.g., infrared printer, IR-aware computers).
8		Microphone	Inputs sounds and voices into your computer.
9		Palmrest	Comfortable support area for your hands when you use the computer.
10		Keyboard	Inputs data into your computer.
11		Speake	Outputs sound.

Left Panel

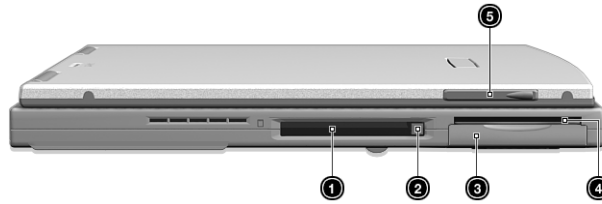

#	Icon	Item/ Port	Description
1		PCMCIA (PC card) port	Connects to one Type II 16-bit PC card or 32-bit cardbus PC card.
2		PC card eject button	Ejects PC card from the card slot.
3		Smart card slot	Slot for smart card interface with pre-boot authentication systems.
4		Hard disk bay	Houses the computer's removable hard disk (secured by a screw).
5		Video capture kit slot	Accepts the video capture kit option on the left side of the computer.



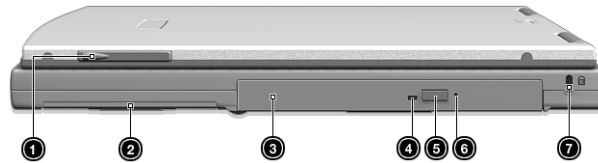



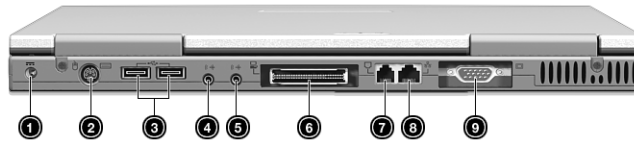

Right Panel



#	Icon	Item/ Port	Description
1		Video capture kit slot	Accepts the video capture kit option on the right side of the computer.
2		Battery bay	Houses the computer's battery pack.
3		AcerMedia drive bay	Houses the computer's removable media drive (CD-RW, CD-ROM, DVD-ROM, or 2nd hard disk).
4		AcerMedia drive activity light	Lights up when media drive is being accessed.
5		AcerMedia drive eject button	Press to eject the media drive tray.
6		AcerMedia drive emergency eject hole	When the media drive tray cannot be ejected (i.e., using the AcerMedia drive eject button), insert a paperclip to manually eject the tray.
7		Security keylock	Connects to a Kensington-compatible key-based computer security lock.

Rear Panel



#	Icon	Item/ Port	Description
1		Power jack	Connects to an AC adapter.
2		PS/2 port	Connects to any PS/2-compatible device (e.g., PS/2 keyboard/ mouse/ keypad).
3		USB ports (two)	Connects to any Universal Serial Bus devices (e.g., USB mouse, USB camera).
4		Line-in jack	Accepts audio line-in devices (e.g., audioCD player, stereo walkman).
5		Speaker/ headphone-out jack	Connects to audio line-out devices (e.g., speakers, headphone).
6		Expansion port	I/O replicator or EasyPort expansion devices.
7		Modem port	Connects to a phone line.
8		LAN port	Connects to an Ethernet (10BaseT) or Fast Ethernet (100BaseT)-based network.
9		External display port	Connects to a display device (e.g., external monitor, LCD projector) and displays up to 64K colors at 1280x1024 resolution.

Bottom Panel

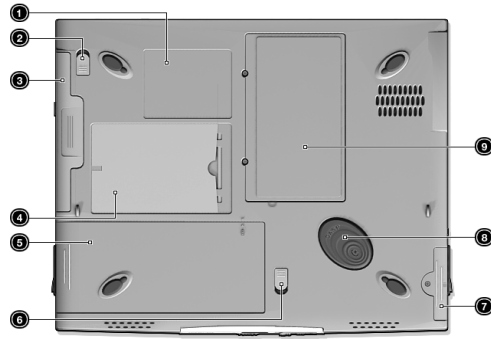







#	Icon	Item/ Port	Description
1		Serial number label	Your computer's unique serial number.
2		AcerMedia drive bay release latch	Unlatches to release the AcerMedia drive from its bay.
3		AcerMedia drive	Your computer's removable media storage.
4		Personal identification slot	Insert a business card or similar-sized identification card to personalize your computer.
5		Battery bay	Houses the computer's battery pack.
6		Battery release latch	Unlatches the battery to remove the battery pack.
7		Hard disk drive bay screw	Protects your hard disk against shocks.
8		Hard disk anti-shock protection	Protects your hard disk against shocks.
9		Memory compartment	Houses the computer's main memory.

Indicators

The computer has seven easy-to-read status icons below the display screen.



The Power and Sleep status icons are visible even when you close the display cover so you can see the status of the computer while the cover is closed.

Icon	Function	Description
	Wireless Communication	Lights when theBlue Tooth/ Wireless LAN capabilities are enabled.
	Power	Lights when the computer is on.
	Sleep	Lights when the computer enters Sleep mode.
	Media Activity	Lights when the floppy drive, hard disk or EasyLink Combo drive is active.
	Battery Charge	Lights when the battery is being charged.
	Caps Lock	Lights when Caps Lock is activated.
	Num Lock	Lights when Num Lock is activated.

Keyboard

The keyboard has full-sized keys and an embedded keypad, separate cursor keys, two Windows keys and twelve function keys.

Special keys

Lock keys

The keyboard has three lock keys which you can toggle on and off.



Lock key	Description
Caps Loc	When Caps Lock is on, all alphabetic characters typed are in uppercase.
Num Lock (Fn-F11)	When Num Lock is on, the embedded keypad is in numeric mode. The keys function as a calculator (complete with the arithmetic operators +, -, *, and /). Use this mode when you need to do a lot of numeric data entry. A better solution would be to connect an external keypad.
Scroll Lock (Fn-F12)	When Scroll Lock is on, the screen moves one line up or down when you press the up or down arrow keys respectively. Scroll Lock does not work with some applications.

NOTE: To access the Num Lock and Scroll Lock functions, hold the Fn key down while pressing the F11 and F12 keys respectively.

Embedded numeric keypad

The embedded numeric keypad functions like a desktop numeric keypad. It is indicated by small characters located on the upper right corner of the keycaps. To simplify the keyboard legend, cursor-control key symbols are not printed on the keys.











Desired Access	Num lock on	Num lock of
Number keys on embedded keypad	Type numbers in a normal manner.	
Cursor-control keys on embedded keypad	Hold Shift while using cursor-control keys.	Hold Fn while using cursor-control keys.
Main keyboard keys	Hold Fn while typing letters on embedded keypad.	Type the letters in a normal manner.

NOTE: If an external keyboard or keypad is connected to the computer, the Num Lock feature automatically shifts from the internal keyboard to the external keyboard or keypad.

Windows keys

The keyboard has two keys that perform Windows-specific functions.



Key	Description
Windows logo key 	Start button. Combinations with this key perform shortcut functions. Below are a few examples: <ul style="list-style-type: none">  + Tab (Activates next taskbar button)  + E (Explores My Computer)  + F (Finds Document)  + M (Minimizes All) Shift +  + M (Undoes Minimize All)  + R (Displays the Run... dialog box)
Application key 	Opens a context menu (same as a right-click).



Hot Keys

The computer employs hot keys or key combinations to access most of the computer's controls like screen brightness, volume output and the BIOS Utility

To activate hot keys, press and hold the Fn key before pressing the other key in the hot key combination.



Hot key	Icon	Function	Description
Fn-I	?	Hot key help	Displays help on hot keys.
Fn-M		Setup	Accesses the computer's configuration utility
Fn-N		Power Management Scheme Toggle	Switches the power management scheme used by the computer (function available if supported by operating system).
Fn-O	Z ^z	Sleep	Puts the computer in Sleep mode.
Fn-P		Display Toggle	Switches display output between the display screen, external monitor (if connected) and both the display screen and external monitor.
Fn-Q		Screen Blank	Turns the display screen backlight off to save power. Press any key to return.
Fn-R		Touchpad Toggle	Turns the internal touchpad on and off.
Fn-S		Speaker Toggle	Turns the speakers on and off.
Fn-W		Volume up	Increases the speaker volume.
Fn-Y		Volume down	Decreases the speaker volume.
Fn-X		Brightness up	Increases the screen brightness.

Hot key	Icon	Function	Description
Fn-Z		Brightness down	Decreases the screen brightness.
a Gr-Euro		Euro	Types the Euro symbol (available on some models).

The Euro symbol

If your keyboard layout is set to United States-International or United Kingdom or if you have a keyboard with a European layout, you can type the Euro symbol on your keyboard.

NOTE: For US keyboard users: The keyboard layout is set when you first set up Windows. For the Euro symbol to work, the keyboard has to be set to United States-International.

To verify the keyboard type:

1. Click on **Start, Settings, Control Panel**.
2. Double-click on **Keyboard**.
3. Click on the **Language** tab.
4. Verify that the keyboard layout used for “En English (United States)” is set to United States-International.

If not, select and click on **Properties**; then select **United States-International** and click on **OK**.

5. Click on **OK**.

To type the Euro symbol:

1. Locate the Euro symbol on your keyboard.
2. Open a text editor or word processor
3. Hold **a Gr** and press the Euro symbol.

NOTE: Some fonts and software do not support the Euro symbol. Please refer to <http://www.microsoft.com/typography/faq/faq12.htm> for more information.

Launch Keys

Located at the top of the keyboard are five buttons. These buttons are called launch keys. They are designated as P1, P2, P3, mail button and Web browser button. By default, buttons P1 and P2 are users programmable. The mail button is used to launch the email application. The LED of the mail button will flash when the user has received an incoming email. The P3, by default is used to launch a multimedia application that came bundled with your system. The Web browser button, by default, is used to launch your Internet browser.



Hardware Specifications and Configurations

Main board Major Chips

Item	Controller
System core logic	82815EM/ ICH2-M
Super I/O controller	Kahuna
Audio controller	ALC200
Video controller	Intel Solano2-M
IDE controller	ICH2-
Keyboard controller	Kahuna
RTC	ICH2-
PCMCIA Controller	OZ711

Processor

Item	Specification
CPU type	Intel Coppermine 800 MHz ~ 1 GHz processor with 256 Kbytes on-die L2 cache
CPU package	MBGA package
CPU core voltage	1.6V/1.35V
CPU I/O voltage	1.5V

BIOS

Item	Specification
BIOS vendor	PhoenixBIOS
BIOS version	V1.0 R00-C9
BIOS ROM type	LPC Flash ROM
BIOS ROM size	512 KB
BIOS package	32-pin TSSOP
Supported protocols	ACPI 1.0b, HDD Password, Int 13h Extensions, S4BIOS for Win98, PnP BIOS 1.0a, SMBIOS 2.3, Simple Boot Flag 1.0, PCI 2.1 USB specification 1.0., PCI Bus Power Management interface Specification, Boot Block, SMI 1.2, EPP/IEEE 1284, ECP/IEEE 1284 1.7 & 1.9, IrDA, PS/2 keyboard and mouse, VESA VGA BIOS, DDC-2B, CD-ROM bootable
BIOS password control	Set by switch, see SW2 settings

Second Level Cache

Item	Specification
Cache controlle	Built-in CPU
Cache size	256 KB
1st level cache control	Always enabled
2nd level cache control	Always enabled
Cache scheme control	Fixed in write-back

System Memory

Item	Specification
Memory controller	Built-in 82815E
Onboard memory size	0 MB
DIMM socket number	2 sockets
Supports memory size per socket	128 MB
Supports maximum memory size	256MB (128MB x 2)
Supports DIMM type	SDRAM
Supports DIMM speed	100 MHz
Supports DIMM voltage	3.3V
Supports DIMM package	144 pin so-DIM
Memory module combinations	You can install memory modules in any combinations as long as they match the above specifications.

Memory Combinations

Slot 1	Slot 2	Total Memory
0 MB	128 MB	128 MB
128 MB	0 MB	128 MB
128 MB	128 MB	256 MB

Above table lists some system memory configurations. You may combine DIMMs with various capacities to form other combinations.

NOTE: The shipping specification for DIMM combination is 64MB in slot 1.

LAN Interface

Item	Specification
LAN Interface/Chipset	Intel ICH2-M integrated LAN controller with 82562ET PHY
Supports LAN protocol	10/100 Mbps
LAN connector type	RJ45
LAN connector location	Rear side

Wireless LAN Interface

Item	Specification
Wireless LAN interface	Mini PCI interface IEEE 802.11b LAN card
Channel support Default channel support	Covering the FCC subset of the IEEE802.11b ISM band
Antenna diversity support	Enabled or Disabled
Enable/disable radio	Support FAA requirement
Encryption support	Support both 60(64)-bit Wired Equivalent Privacy (WEP) encryption and 128-bit RC4 encryption
PCI configuration data	PC98/99 compliant

NOTE: The IEEE 802.11b MiniPCI card has two RF connectors mounted, identified as Main and Auxiliary connector. Since there is only one card variant in this controlled deployment program, it is chosen that antenna diversity can be obtained by use of an external antenna diversity switch, which is connected to the Main RF connector, and controlled by DC-switching voltage provided through this connector

Modem Interface

Item	Specification
Modem Interface/Chipset	MDC interface/ Built in ICH2-M AC'97 2.1 compliant digital controller interface
Fax modem data baud rate (bps)	14.4K
Data modem data baud rate (bps)	56K
Supports modem protocol	V.90 data modem 56K, V.90 fax modem 14.4K and digital line protection operation
Modem connector type	RJ11
Modem connector location	Rear side

Hard Disk Drive Interface

Item	Specification			
Vendor & Model Name	DK23BA-10	DK23BA-20	IBM DJSA-21	IBM DJSA-220
Capacity (GB)	10	20	10	20
Bytes per sector	512	512	512	512
Logical heads	16	16	16	16
Logical sectors	63	63	63	63
Drive Format				
Logical cylinders	16383	16383	16383	16383
Physical read/write heads	2	4	2	4
Disks	1	2	1	2
Spindle speed (RPM)	4200	4200	4200	4200
Performance Specifications				
Buffer size (KB)	512	2048	512	2048
Interface	IDE (ATA-5)	IDE (ATA-5)	IDE (ATA-5)	IDE (ATA-5)
Data transfer rate (disk buffer, MB/s)	14.1-24.8	14.1-24.8	13.625-25.375	13.625-25.375
Data transfer rate (host buffer, MB/s)	16.6 (PIO Mode-4) 66.6 (Ultra DMA Mode-4)			
DC Power Requirements				
Voltage tolerance	5+/-5%	5+/-5%	5+/-5%	5+/-5%

CD-R/W Interface

Item	Specification
Vendor & model name	KME UJDA330 8X / 4X / 24X
Performance Specification	
Transfer rate (KB/sec)	CAV Mode: 775~1800 blocks/sec Mode 1: 1550~3600 kBytes/sec Mode 2: 1768~4106kBytes/sec
Access time (typ.)	Random: 150 ms Full Stroke: 300 ms
Rotation speed	5000 rp (typ.)

CD-R/W Interface

Item	Specification
Buffer memory	2 MB
Interface	ATAPI
Applicable disc format	CD-DA, CD-ROM (Mode-1, Mode-2), CD-ROM XA MODE-2 (FORM-1, FORM-2), Multi-Session Photo CD, CD-I, Video CD, Enhanced CD & CD PLUS Compatible, CD-R/W
Loading mechanism	Drawer with soft eject and emergency eject hole
Power Requirement	
Input Voltage	5 V

DVD-ROM Interface

Item	Specification	
Vendor & model name	Toshiba SD-C2502	
Performance Specification	With CD Diskette	With DVD Diskett
Transfer rate (KB/sec)	1,500KB/sec ~ 3,600KB/sec. (FULL - CAV)	4.58MB/sec ~ 11.08MB/sec. (FULL - CAV)
Access time (typ.)	110 ms	150 ms
Rotation speed	4800 rpm (typ.)	3700 rpm (typ.)
Buffer memory	512 KB	512 KB
Interface	ATAPI	
Applicable disc format	DVD-ROM, DVD-Video, CD-DA, CD-ROM (Mode-1, Mode-2), CD-ROM XA MODE-2 (FORM-1, FORM-2), Multi-Session Photo CD, CD-I, Video CD, Enhanced CD & CD PLUS Compatible, CD-R/W	
Loading mechanism	Drawer with soft eject and emergency eject hole	
Power Requirement		
Input Voltage	5 V	

Audio Interface

Item	Specification
Audio controller	ALC200
Audio onboard or optional	Built-in ICH2-M
Mono or Stereo	Stereo
Resolution	16 bit
Compatibility	Windows Sound System (WSS), Microsoft PC98/PC99
Mixed sound source	Voice, Synthesizer, Line-in, Microphone, CD
Voice channel	6/16-bit, mono/stereo
Sampling rate	48 KHz
Internal microphone	Yes
Internal speaker / Quantity	Yes/ 2 pieces
Supports PnP DMA channel	DMA channel 0 DMA channel 1
Supports PnP IRQ	IRQ3, IRQ7, IRQ10, IRQ11

Video Interface

Item	Specification
Vendor & model name	Intel Solano2-M

Video Interface

Item	Specification
Chip voltage	1.8V
Supports ZV (Zoomed Video) port	No
Graph interface	DVO I/F
Maximum resolution (LCD)	1024x768 (24 bit colors)
Maximum resolution (CRT)	1024x768 (24 bit colors)

Video Memory

Item	Specification
Fixed or upgradeable	W986432AH-7 SDRAM-133MHz
Video memory size	11MB

Video Resolutions Mode

Resolution	Refresh Rate	
	CRT Only	LCD/CRT Simultaneous
640x480x256	85	60
640x480x64K	85	60
640x480x16	85	60
800x600x256	85	60
800X600X64K	85	60
1024x768x25	60, 75	60

USB Port

Item	Specification
USB Compliancy Level	1.0
UHCI	USB 1.0
Number of USB port	2
Location	Rear side
Serial port function control	Enable/Disable by BIOS Setup

IrDA Port

Item	Specification
IrDA FIR port controller	Ultra I/O LPC47N252 208P
Number of IrDA FIR port	1
Location	Front side
IrDA FIR port function control	Enable/disable by BIOS Setup
Optional IrDA FIR port (in BIOS Setup)	2F8h, 3F8h, 3E8h, 2E8
Optional IrDA FIR port IRQ (in BIOS Setup)	IRQ3, IRQ4
Optional IrDA FIR port DRQ (in BIOS Setup)	DRQ3, DRQ1, DRQ0

PCMCIA Port

Item	Specification
PCMCIA controller	O2 Micro OZ711 CardBus controller (Tarzan)
Supports card type	Type II/I
Number of slots	One type II One for smart card (upper with HDD frame)
Access location	Left side
Supports ZV (Zoomed Video) port	No
Supports 32 bit CardBus	Yes

Smart Card CardBus Interface

Item	Specification
Power management	Compliant with ACPI-PCI Bus Power Management interface Specification Rev 1.1
Hot insertion and removal	Enabled or Disabled
Memory access	Support Direct Memory Access for PC/PCI and PCI/Way on PC Card socket
Data transfer	Support multiple FIFOs for PCI/CardBus data transfer
Programmable interrupt protocol	PCI, PCI+ISA, PCI/Way, or PC/PCI interrupt signaling modes

Keyboard

Item	Specification
Keyboard controller	Kahuna controlle
Keyboard vendor & model name	API
Total number of keypads	84/85/88-key
Windows 95 keys	Yes
Internal & external keyboard work simultaneously	Yes

Battery

Item	Specification		
Vendor & model name	Sanyo 3UF103450P-2	SMPLO Main BTP-37D1	SMPLO Second SBC-6E1
Battery Type	Li-ion	Li-ion	Li-ion
Pack capacity	3300 mAH	3100 mAH	3100 mAH
Cell voltage	3.7V	3.7V	3.7V
Number of battery cell	6	6	6
Package configuration	3S-2P	3S-2P	3S-2P
Package voltage	11V	11V	11V

DC-AC LCD Inverter

Item	Specification	
Vendor & model name	Ambit T62I194.00	Sumida IV002 (IV09117/T)
Input voltage (V)	7.5 ~ 21V	12V
Input current (mA)	1000mA max	400 mA max
Output voltage (Vrms, no load)	1450Vrm	1400Vrm
Output voltage frequency (kHz)	45K-80K Hz	55K-65K Hz
Output Current/Lamp	6.0 mA max	6.0 mA max

NOTE: DC-AC inverter is used to generate very high AC voltage, then support to LCD CCFT backlight user, and is also responsible for the control of LCD brightness. Avoid touching the DC-AC inverter area while the system unit is turned on.

NOTE: There is an EEPROM in the inverter, which stores its supported LCD type and ID code. If you replace a new inverter or replace the LCD with a different brand, use Inverter ID utility to update the ID information.

LCD

Item	Specification	
Vendor & model name	LG LP141X7	IBM ITXG77 C
Mechanical Specifications		
LCD display area (diagonal, inch)	14.1	14.1
Display technology	TFT	TFT
Resolution	XGA, 1024x768	XGA, 1024x76
Supports colors	262K	262K
Optical Specification		
Brightness control	keyboard hotkey	keyboard hotkey
Contrast control	No	No
Electrical Specification		
Supply voltage for LCD display (V)	3.3	3.3
Supply voltage for LCD backlight (Vrms)	725	650

AC Adapter

Item	Specification	
Vendor & model name	Lite-On PA-1600-02	Delta ADP-60DB
Input Requirements		
Maximum input current (A, @90Vac, full load)	1.5 A @ 90Vac 0.9 A @ 180Vac	1.5 A @ 90Vac 0.9 A @ 180Vac
Nominal frequency (Hz)	47 - 63	47 - 6
Frequency variation range (Hz)	47 - 63	47 - 6
Nominal voltages (V)	90 - 264	90 - 264
Inrush current	The maximum inrush current will be less than 50A and 100A when the adapter is connected to 115Vac(60Hz) and 230Vac(50Hz) respectively.	The maximum inrush current will be less than 50A and 100A when th adapter is connected to 115Vac(60Hz) and 230Vac(50Hz) respectively.

AC Adapter

Item	Specification	
Efficiency	It should provide an efficiency of 83% minimum, when measured at maximum load under 115V(60Hz).	It should provide an efficiency of 83 minimum, when measured at maximum load under 115V(60Hz).
Output Ratings (CV mode)		
DC output voltage	19 +1.5/-0 V	19 +1.5/-0 V
Noise + Ripple	300m Vp-p max (20MHz bandwidth)	300m Vp-p max (20MHz bandwidth)
Load	0 A (min.) 3.16 A (max.)	0 A (min.) 3.16 A (max.)
Output Ratings (CC mode)		
DC output voltage	+12V ~ +19V	+12V ~ +19V
Constant output	2.75 ± 0.2 A	2.75 ± 0.2 A
Dynamic Output Characteristics		
Turn-on delay time	2 sec. (@115Vac)	2 sec. (@115Vac)
Hold up time	4 ms min. (@115 Vac input, full load)	4 ms min. (@115 Vac input, full load)
Over Voltage Protection (OVP)	24 V	24 V
Short circuit protection	Output can be shorted without damage	Output can be shorted without damage
Electrostatic discharge (ESD)	15kV (at air discharge) 8kV (at contact discharge)	15kV (at air discharge) 8kV (at contact discharge)
Dielectric Withstand Voltage		
Primary to secondary	1500 Vac (or 2121 Vdc), 10 mA for 1 second	1500 Vac (or 2121 Vdc), 10 mA for 1 second
Leakage current	0.25 mA max. (@ 254 Vac, 60Hz)	0.25 mA max. (@ 254 Vac, 60Hz)
Regulatory Requirements	Internal filter meets: 1. FCC class B requirements. (USA) 2. VDE 243/1991 class B requirements. (German) 3. CISPR 22 Class B requirements. (Scandinavia) 4. VCCI class II requirements. (Japan)	Internal filter meets: 1. FCC class B requirements. (USA) 2. VDE 243/1991 class B requirements. (German) 3. CISPR 22 Class B requirements. (Scandinavia) 4. VCCI class II requirements. (Japan)

Power Management

Power Saving Mode	Phenomenon
<p>Standby Mode</p> <ul style="list-style-type: none"> <input type="checkbox"/> Waiting time specified by the System Standby value or the operating system elapses without any system activity <input type="checkbox"/> Closing the display cover <input type="checkbox"/> When the computer is about to enter Hibernation mode (e.g., during a battery-low condition), but the Hibernation file is invalid or not present. <input type="checkbox"/> When customized functions for power management are set to Standby and the corresponding action is taken. <input type="checkbox"/> Invoked by the operating system power-saving modes. 	<ul style="list-style-type: none"> <input type="checkbox"/> The buzzer beeps <input type="checkbox"/> The Sleep indicator lights up
<p>Hibernation Mode</p> <ul style="list-style-type: none"> <input type="checkbox"/> When customized functions for power management are set to Hibernation and the corresponding action is taken. <input type="checkbox"/> Invoked by the operating system power-saving modes. 	<ul style="list-style-type: none"> <input type="checkbox"/> All power shuts off
<p>Display Standby Mode</p> <p>Keyboard, built-in touchpad, and an external PS/2 pointing device are idle for a specified period.</p>	<ul style="list-style-type: none"> <input type="checkbox"/> The display shuts off
<p>Hard Disk Standby Mode</p> <p>Hard disk is idle within a specific period of time.</p>	<ul style="list-style-type: none"> <input type="checkbox"/> Hard disk drive is in standby mode. (spindle turned off)

Environmental Requirements

Item	Specification
Temperature	
Operating	+5 ~ +35°C
Non-operating	-20 ~ +60°
Non-operating	-20 ~ +60°C (storage package)
Humidity	
Operating	20% ~ 80% RH, non-condensing
Non-operating	20% ~ 90% RH, non-condensing
Non-operating	20% ~ 90% RH, non-condensing (storage package)
Vibration	
Operating (unpacked)	5 ~ 25.6 Hz: 0.38mm (peak to peak) 25.6 ~ 250 Hz: 0.5G
Non-operating (unpacked)	5 ~ 27.1 Hz: 0.6G 27.1 Hz ~ 50 Hz: 0.41mm (peak to peak) 50 ~ 500 Hz: 2.0G
Non-operating (packed)	5 ~ 62.6 Hz: 0.51mm (peak to peak) 62.6 ~ 500 Hz: 4G

Mechanical Specifications

Item	Specification
Dimensions	308(W) x 247(D) x 24.5~29.9(H) mm for 14.1" TFT
Weight	5 lbs for 14.1" TFT model
I/O Ports	One type II PCMCIA (PC card) slot or one SmartBus slot, two USB ports, one PS/2 keyboard/mouse port, one RJ11 port, one RJ45 port, one VGA port, one line-out jack, one line-in/microphone-in jack, one 100-pin port-replicator connector
Drive Bays	Two
Material	LCD panel & lower Case: Meg-Alloy Others of housing: Plastic
Indicators	Wireless Communication, Power-on LED, Sleep, Media Activity, Battery Status, Caps Lock, Num Lock
Switch	Power

Memory Address Map

Memory Address	Size	Function
00000000-0009FFFF	640 KB	Base memory
000A0000-000BFFFF	128 KB	Video memory
000C0000-000CCFFF	48 KB	Video BIOS
000CA000-000CBFFF	8 KB	I/O ROM
000E0000-000FFFFF	128 KB	System BIOS
00100000-top limited	--	Extended (DIMM) memory
04301000-04301FFF	4 KB	PCMCIA controller (slot 1)
04302000-04302FFF	4 KB	PCMCIA controller (slot 2)
04300000-04300FFFF	64 KB	USB controller
FFFF0000-FFFFFFFF	64 KB	System board extension for PnP BIOS

I/O Address Map

I/O Address	Function
000-00F	DMA controller-1
020-021	Interrupt controller-1
040-043	Timer 1
060, 064	Keyboard controller 8742 chip select
062, 066	System speaker, ACPI embedded controller
061	System speaker
070-073	System CMOS/real-time clock
081-08F	DMA page register
0A0-0A1	Interrupt controller-2
0C0-0DF	DMA controller-2
0F0-0FE	Numeric data processor
170-177	2nd EIDE device (CD-ROM) select
1F0-1F7	1st EIDE device (hard drive) select
3F8-3FF	COM1
2F8-2FF	COM1or FIR (optional)
3E8-3EF	COM1or FIR (optional)
2E8-2EF	COM1or FIR (optional)

I/O Address Map

I/O Address	Function
376, 3F6	Intel ICH2-M PCI BusMaster IDE Controller
378, 37F	Parallel port
278, 27F	Parallel port 1 (optional)
3BC-3BF	Parallel port 1 (optional)
3B0-3BB 3C0-3DF	Video Controller
3F0h-3F7	Standard Floppy Disk Controller
4D0-4D1 CF8-CFF	PCI configuration register

IRQ Assignment Map

Interrupt Channel	Function
NMI	System errors
IRQ0	System timer
IRQ1	Keyboard controller
IRQ2	Cascade
IRQ3	FIR
IRQ4	Serial port 1
IRQ5	Not used
IRQ6	Not used
IRQ7	Parallel port
IRQ8	Real time clock
IRQ9	ACPI
IRQ10	USB, SMBus, Wireless LAN
IRQ11	CardBus controller, Smart card, Internal LAN, VGA
IRQ12	PS2 pointing device
IRQ13	Numeric data processor
IRQ14	1st EIDE device (hard disk)
IRQ15	2nd EIDE device (CD-ROM drive)

DMA Channel Assignment

DMA Channel	Function
DRQ0	Audio or FIR (optional)
DRQ1	ECP or Audio or FIR (optional)
DRQ2	Not used
DRQ3	ECP or FIR (optional)
DRQ4	Not used
DRQ5	Not used
DRQ6	Not used
DRQ7	Not used

System Utilities

BIOS Setup Utility

The BIOS Setup Utility is a hardware configuration program built into your computer's BIOS (Basic Input/Output System).

Your computer is already properly configured and optimized, and you do not need to run this utility. However, if you encounter configuration problems, you may need to run Setup. Please also refer to Chapter 4 Troubleshooting when problem arises.

To activate the BIOS Utility, press **F2** during POST (while the TravelMate logo is being displayed).

PhoenixBIOS Setup Utility	
Information	Main Advanced Security Boot Exit
CPU Type	Pentium(R) III
CPU Speed	800 Mhz
System Memory:	640 KB
Extended Memory:	62976 KB
HDD1 Serial Number	10NAWV
HDD2 Serial Number	None
System BIOS Version	V1.0 R00-B3
VGA BIOS Version	V23.02
KBC Version	V01.09
Serial Number	0123456789
Asset Tag Number	
Product Name	TravelMate 610
Manufacture Name	Acer
UUID Number	00000000-0000-0000-0000-000000000000
F1 Help ↑↓ Select Item F5/F6 Change Values F9 Setup Defaults Esc Exit ← Select Menu Enter Select > Sub-Menu F10 Save and Exit	

Navigating the BIOS Utility

There are six menu options: System Information, Basic System Settings, Startup Configuration, System Security, Boot Options and Exit Setup.

To enter a menu, highlight the item using the **cursor up/down** keys, then press **Enter**.

Within a menu, navigate through the BIOS Utility by following these instructions:

- Use the **cursor up/down** keys to move between the parameters.
- Press **F5** or **F6** to change the value of a parameter.

NOTE: You can change the value of a parameter if it is enclosed in square brackets. Navigation keys are shown at the bottom of the screen.

- Press **Enter** to enter a submenu (designated by an arrow to the left of the parameter) if available

NOTE: Press Esc to exit the current sub-menu

- Press **F9** to load default setup values
- Press **F10** to save your changes and exit the BIOS Utility
- Press **Esc** to access the Exit menu

System Information

The System Information screen displays a summary of your computer hardware information.

PhoenixBIOS Setup Utility	
Information	Main Advanced Security Boot Exit
CPU Type	Pentium(R) III
CPU Speed	800 Mhz
System Memory:	640 KB
Extended Memory:	62976 KB
HDD1 Serial Number	10NAWV
HDD2 Serial Number	None
System BIOS Version	V1.0 R00-B3
VGA BIOS Version	V23.02
KBC Version	V01.09
Serial Number	0123456789
Asset Tag Number	
Product Name	TravelMate 610
Manufacture Name	Acer
UUID Number	00000000-0000-0000-0000-000000000000
F1 Help ↑↓ Select Item F5/F6 Change Values F9 Setup Defaults Esc Exit ← Select Menu Enter Select > Sub-Menu F10 Save and Exit	

NOTE: The screen above is a sample and may not reflect the actual data on your computer.

The following table describes the information in this screen

Parameter	Description
CPU Type & Speed	Describes the type of CPU installed in the system.
System Memory	
Extended Memory	
HDD Serial Number	Shows the serial number of the hard disk.
System BIOS Version	Shows the version number of the BIOS.
VGA BIOS Version	Shows the version number of the VGA display BIOS.
KBC Version	
Serial Number	Shows the serial number of the computer.
Asset Tag Number	Shows the asset tag number of the computer.
Product Name	Shows the product name of the computer.
Manufacture Name	Shows the manufacturer of the computer.
UUID Number	Shows the universally unique identifier of your computer.

The items in this screen are important and vital information about your computer. If you experience computer problems and need to contact technical support, this data helps our service personnel know more about your computer.

Basic System Settings

The Basic System Settings screen allows you to set the system date and time.

PhoenixBIOS Setup Utility					
Information	Main	Advanced	Security	Boot	Exit
System Time:	[10:31:35]				Item Specific Help
System Date:	[01/11/2001]				
Boot Display	[Both]				
QuickBoot Mode:	[Enable]				
Startup Screen	[Enable]				
Boot on LAN	[Disable]				
Hotkey Beep	[Enable]				
F1 Help ↑↓ Select Item F5/F6 Change Values F9 Setup Defaults Esc Exit ← Select Menu Enter Select > Sub-Menu F10 Save and Exit					

The following table describes the parameters in this screen

Parameter	Description	Format
System Date	Sets the system date.	DDD MMM DD, YYYY (day-of-the-week month day, year)
System Time	Sets the system time.	HH:MM:SS (hour:minute:second)
Boot Display	Sets the display device when the computer starts up.	Both or Auto
QuickBoot Mode	QuickBoot allows your computer to skip certain tests at start-up to speed-up the boot process.	Enable or Disable
Startup Screen	When enabled, it allows your computer to display the compute logo on boot-up.	Enable or Disable
Boot on LAN	When enabled, it allows your computer to boot-up via the network	Disabl or Enable
Hotkey Beep	Enables or disables a beep when a hotkey is pressed.	Enable or Disable

Startup Configuration

The Startup Configuration screen contains parameter values that define how your computer behaves on system startup.

PhoenixBIOS Setup Utility					
Information	Main	Advanced	Security	Boot	Exit
> IDE Primary Master		[10056MB]		Item Specific Help	
> IDE Secondary Master		[CD-ROM]			
> Onboard Device Configuration					
> PCI IRQ Routing					
Resume on LAN/MODEM Access		[Enabled]			
Reset Configuration Data:		[Yes]			
CPU Power Management Mode		[Auto]			
SpeedStep(TM) Mode		[Recommended]			
Display Cache		[Disable]			
F1 Help ↑ Select Item F5/F6 Change Values F9 Setup Defaults Esc Exit ← Select Menu Enter Select > Sub-Menu F10 Save and Exit					

The following table describes the parameters in this screen. Settings in **boldface** are the default and suggested parameter settings

Parameter	Description	Options
IDE Primary Master	Pres Enter to access the IDE Primary Master sub menu.	
IDE Secondary Master	Pres Enter to access the IDE Secondary Maste sub-menu.	
Onboard Device Configuration	Pres Enter to access the Onboard Device Configuration sub-menu.	
PCI IRQ Routing	Pres Enter to access the PCI IRQ Routing sub menu.	
Resume on LAN/ MODE Access	When enabled, it allows your computer to resume normal operation when network or modem access is available.	Enabled or Disabled
Reset Configuration Dat	Select Yes to clear the Extended Syste Configuration Data.	Yes or No
CPU Power Management Mode	Set to auto to allow power management of the CPU.	Auto or Disabled
SpeedStep (TM) Mode	Intel SpeedStep technology allows your computer t automatically adjust the CPU speed depending on the power source.	Recommended Maximum Performance Battery Optimized Reversed Disabled
Display Cache	When enabled, it allows VGA local memory control for the display cache.	Disable or Enable

IDE Primary Master

The IDE Primary Master sub-menu contains parameters related to the primary hard disk.

CAUTION: The parameters in this screen are for advanced users only. Typically, you do not need to change the values in this screen. The default setting of **Auto** optimizes all the settings for your hard disk.

PhoenixBIOS Setup Utility	
Advanced	
IDE Primary Master [10056MB]	Item Specific Help
Type: [Auto] Multi-Sector Transfers: [16 Sectors] LBA Mode Control: [Enable] 32 Bit I/O: [Enable] Transfer Mode: [Fast PIO 4] Ultra DMA Mode: [Mode 4]	
F1 Help ↑↓ Select Item F5/F6 Change Values F9 Setup Defaults Esc Exit ←→ Select Menu Enter Select > Sub-Menu F10 Save and Exit	

IDE Secondary Master

The IDE Secondary Master sub-menu contains parameters related to the AcerMedia bay drive.

CAUTION: The parameters in this screen are for advanced users only. Typically, you do not need to change the values in this screen. The default setting of Auto optimizes all the settings for your AcerMedia bay drive.

PhoenixBIOS Setup Utility	
Advanced	
IDE Secondary Master [CD-ROM]	Item Specific Help
Type: [Auto] Multi-Sector Transfers: [Disable] LBA Mode Control: [Disable] 32 Bit I/O: [Enable] Transfer Mode: [Fast PIO 4] Ultra DMA Mode: [Mode 2]	
F1 Help ↑↓ Select Item F5/F6 Change Values F9 Setup Defaults Esc Exit ←→ Select Menu Enter Select > Sub-Menu F10 Save and Exit	

Onboard Devices Configuration

The Onboard Devices Configuration sub-menu contains parameters that are related to computer hardware.

CAUTION: The parameters in this screen are for advanced users only. Typically, you do not need to change the values in this screen because these values are already optimized.

PhoenixBIOS Setup Utility	
Advanced	
Onboard Device Configuration	Item Specific Help
Serial Port: [Enable] Base Address [3F8/IRQ 4] IrDA FIR: [Enable] Mode: [FIR] Base Address [2F8/IRQ 3] DMA channel: [DMA 3] Parallel port: [Enable] Mode: [Bi-directional] Base I/O address: [378] Interrupt: [IRQ 7]	
F1 Help ↑↓ Select Item F5/F6 Change Values F9 Setup Defaults Esc Exit ←→ Select Menu Enter Select > Sub-Menu F10 Save and Exit	

The following table describes the parameters in this screen. Settings in **boldface** are the default and suggested parameter settings

Parameter	Description	Options
Serial Port	Enables or disables the serial port. When enabled, you can set the base I/O address and interrupt request (IRQ) of the serial port.	Enable or Disable 3F8/ IRQ 4 , 2F8/ IRQ 3, 3E8/ IRQ 4 or 2E8/ IRQ 3
IrDA FIR	Enables or disables the infrared port. When enabled, you can set the base I/O address, interrupt request (IRQ) and direct memory access (DMA) channel of the infrared port.	Enable or Disable 2F8/ IRQ 3 , 3E8/ IRQ 4, 2E8/ IRQ 3 or 3F8/ IRQ 4 DMA 3 or DMA 1
Parallel Port	Enables or disables the parallel port. When enabled, you can set the base I/O address, interrupt request (IRQ) and operating mode of the parallel port. When the operating mode is set to ECP, you can set the DMA channel of the parallel port.	Enable or Disable Bi-directional , EPP, ECP or Output only 378 , 278 or 3BC IRQ 7 or IRQ 5 DMA 1 or DMA 3

PCI IRQ Routing

The PCI IRQ Routing sub-menu allows you to set IRQs for PCI devices.

CAUTION: The parameters in this screen are for advanced users only. Typically, you do not need to change the values in this screen because these values are already optimized.

PhoenixBIOS Setup Utility			
Advanced			
PCI IRQ Routing		Item Specific Help	
PIRQ A#: [11] PIRQ B#: [10] PIRQ C#: [11] PIRQ D#: [10] PIRQ E#: [11] PIRQ F#: [10] PIRQ G#: [11] PIRQ H#: [10]			
F1 Help	↑↓ Select Item	F5/F6 Change Values	F9 Setup Defaults
Esc Exit	←→ Select Menu	Enter Select > Sub-Menu	F10 Save and Exit

System Security

The System Security screen contains parameters that help safeguard and protect your computer from unauthorized use.

PhoenixBIOS Setup Utility				
Information	Main	Advanced	Security	Boot Exit
Set Supervisor Password	[Enter]			Item Specific Help
Set User Password	[Enter]			
Password on boot:	[Enable]			
Set Hard Disk Password	[Enter]			
Processor Serial Number	[Disable]			
F1 Help ↑ Select Item F5/F6 Change Values F9 Setup Defaults Esc Exit ← Select Menu Enter Select > Sub-Menu F10 Save and Exit				

The following table describes the parameters in this screen. Settings in **boldface** are the default and suggested parameter settings

Parameter	Description	Options
Set Supervisor Password	When set, this password protects the BIOS Utility and Notebook Manager from unauthorized use. Press Enter to set this password.	
Set User Password	When set, this password protects the computer from unauthorized use. Press Enter to set this password (requires the Supervisor Password to be set first).	
Password on boot	When enabled, a password is requested when the system boots up.	Enable or Disable
Set Primary Hard Disk Password	When set, this password protects your hard disk from unauthorized access. Press Enter to set this password.	
Processor Serial Number	The Pentium III processor includes a unique serial number which allows individual CPUs to be identified. You can turn off this feature by setting this parameter to Disabled.	Disable or Enable

Setting a Password

Follow these steps:

1. Use the cursor up/ down keys to highlight a password parameter (Setup, Power-on or Hard Disk) and press the **Enter** key. The password box appears.
2. Type a password. The password may consist of up to seven characters (A-Z, a-z, 0-9).
3. Press **Enter**. Re-type the password to verify your first entry and press **Enter**.
4. After setting the password, the computer automatically sets the chosen password parameter to Present.

Removing a Password

Should you want to remove a password, do the following:

1. Use the cursor up/ down keys to highlight a password parameter (Setup, Power-on or Hard Disk) and press the **Enter** key. The password box appears.
2. Enter the current password and press **Enter**.
3. Press Enter twice without entering anything in the new field and confirm password fields to remove the existing password.

NOTE: When you want to remove the Hard Disk (or 2nd Hard Disk) password, you are prompted for the current Hard Disk password before it is removed.

Changing a Password

To change a password, follow these steps:

- Remove the current password. See “Removing a Password” on page 36.
- Set a new password. See “Setting a Password” on page 36.

Boot Options

The Boot menu contains parameter values that determine in what order the bootable devices in your computer start-up.

PhoenixBIOS Setup Utility	
Information	Main Advanced Security Boot Exit
Removable Devices +Hard Drive CD-ROM Drive	Item Specific Help
F1 Help ↑ Select Item F5/F6 Change Values F9 Setup Defaults Esc Exit ← Select Menu Enter Select > Sub-Menu F10 Save and Exit	

Setting the Boot Drive Sequence

Use the cursor up/ down keys to select a boot device, then press **F5** or **F6** to change its order. Items with a + sign can be further expanded.

Exit Setup

This menu contains exit options.

PhoenixBIOS Setup Utility					
Information	Main	Advanced	Security	Boot	Exit
Exit Saving Changes Exit Discarding Changes Load Setup Defaults Discard Changes Save Changes				Item Specific Help	
F1 Help		↑↓ Select Item		F5/F6 Change Values	
Esc Exit		←→ Select Menu		Enter Execute Command	
				F9 Setup Defaults	
				F10 Save and Exit	

The following table describes the parameters in this screen. Settings in **boldface** are the default and suggested parameter settings

Parameter	Description
Exit Saving Changes	Saves your changes and exits the BIOS Utility.
Exit Discarding Changes	Discards your changes and exits the BIOS Utility.
Load Setup Defaults	Loads default settings for all setup parameters.
Discard Changes	Discards your changes.
Save Changes	Saves your changes.

BIOS Flash Utility

The BIOS flash memory update is required for the following conditions:

- New versions of system programs
- New features or options

Use the AFlash utility to update the system BIOS flash ROM.

NOTE: Do not install memory-related drivers (XMS, EMS, DPMI) when you use AFlash.

NOTE: This program contains a readme.txt file. This readme.txt file will introduce on how to use AFlash utility.

Executing Flash Program

IMPORTANT: If this diskette is not bootable, do the following actions before you use it:

1. Create a bootable disk.
2. Copy all AFlash files into this bootable diskette.
3. Put the bootable disk into TravelMate 610 series module, then reboot.

IMPORTANT: Never turn off the system power while Flash BIOS is programming. This will damage your system.

4. After Flash BIOS is done, reboot the system.

NOTE: If there are any problems occurred during BIOS update, see for troubleshooting.

System Utility Diskette

This utility diskette is for the Acer TravelMate 610 notebook machine. It provides the following functions:

1. Read Panel ID Setting
2. Write Panel ID Utility
3. Thermal and Fan Utility
4. Main Board Data Utility

To use this diskette, first boot from this diskette, then a "Microsoft Windows 98 Startup Menu" prompt you to choose the testing item. Follow the instructions on screen to proceed.

NOTE: This program contains a readme.txt file. This readme.txt file will introduce each test utility and its functions.

IMPORTANT: If this diskette is not bootable, do the following actions before you use it:

1. Do system transfers.
2. Copy the following files to A:\.
HIMEM.SYS
RAMDRIVE.SYS

Read Panel ID Setting

This function will display registered information on the panel ID of Acer TravelMate 610 series. Then, Panel ID is set to EEPROM.

Write Panel ID Setting

This function will write a default LCD panel ID into EEPROM.

Thermal and Fan Utility

1. Set Thermal Setting

This function will write the default value into EEPROM.

2. Read Thermal

This function will display current system temperature and CPU temperature.

First, the default of thermal range is displayed. For the system temperature, it ranges from 35 to 87 and for the CPU temperature, it is limited to 110. A CPU temperature below 110 is considered as normal temperature.

3. Test Fan

The test item includes fan off test then it will proceed testing the fan for three different ranges of rpm. That is, over 4000 rpm, below 6000 rpm and finally, over 6000 rpm. If these tests succeed, the "PASS" message appears on the screen. Otherwise, an error message is displayed.

Main Board Data Utility

1. Default Setting

The utility provides a strong function which can set all default settings to our EEPROM; such as Panel ID, Thermal Setting, Product Name and Product Manufacture.

NOTE: Product Name should be written as default "TravelMate 610" because remote control of scrollbar(option item) will only identify the Product Name as TravelMate 610.

2. Read Mother board Data

This provides the detailed information of mother board data. That includes Product Name, Manufacture Name, UUID, and serial number.

3. Write Manufacture name

It is allowed to input 4 bytes on the manufacture name and will revise the record into EEPROM automatically.

4. Write MBD UUID

The MBD includes 32 bytes stored in EEPROM. There are two sub-functions:

- a. Create and write a new UUID**
This function is used when the original UUID is lost or damaged.
- b. Write UUID by user keyin**
This function is used when the original UUID is kept. The user can use "Read Main Board Data" function before to get it and have stored it.

5. Write MBD serial number

This function allows to write 19 bytes MBD serial number by user keyin. The serial number can be found on the backside of the machine.

- a. Create and write a new UUID**
This function is used when the original UUID is lost or damaged.
- b. Write UUID by user keyin -**
This function is used when the original UUID is kept. User may use "Read Main Board Data" function first to keep the UUID.

System Diagnostic Diskette

IMPORTANT: ¹The diagnostics program here that we used is called PQA (Product Quality Assurance) and is provided by Acer Headquarters. You can utilize it as a basic diagnostic tool. To get this program, either download it from <http://csd.acer.com.tw> or find it in the TravelMate 610 service CD kit. To better fit local service requirements, your regional office MAY have other diagnostic program. Please contact your regional offices or the responsible personnel/channel to provide you with further technical details.

NOTE: This program contains a readme.txt file. This readme.txt file will introduce each test and its functions.

This diagnostic program is designed to perform the following diagnostic tools for Acer TravelMate 610 notebook machine. It provides the following functions.

1. PQA Test
2. Audio Test
3. USBTest
4. Smart Card Test
5. IR Test
6. Exit

To use this diskette, first boot from this diskette, then a "System Diagnostic Disk Menu" prompts you to choose the testing item. Follow the instructions on screen to proceed.

IMPORTANT: If this diskette is not bootable, do the following actions before you use it:

1. Do system transfers.
2. Copy the following files to A:\
HIMEM.SYS
RAMDRIVE.SYS
CHOICE.COM
MSCDEX.EXE

PQA System Diagnostics

NOTE: This PQA diagnostics program will test Acer TravelMate 610 notebook series' hardware peripherals.

1. When you select One Test, Test command (F2 key) will only work in the first-level menu (Item Test), if you are in sub-level menu, please press ESC to return to upper-level (Item Test) menu.
2. Use Space Bar to select/ deselect a testing item.
3. When testing is done, there will be a testing report, where you could find out whether the testing is successful or not.

Audio Test

The item consists of 3 tests:

1. Config & CD_PlayTest

Insert Audio CD (with Root_directory) into CD-ROM. Press "a" once to stop the CD from playing and then press any key to exit this test.

2. LoopbackTest:

You have to attach "loop_line" into line-in and line-out port on the rear panel of TravelMate 610 for this test. You will see a "PASS" message if test is successful.

3. Built_in Micro_phone test:

Make any sound after pressing enter. Then the machine will start to record the sound you made for about five second, and play it. Please take out "loop_line" before executing the test.

¹ New added description. Please pay attention to it.

4. Exit to main menu:

USB Test

This function will test USB Connect/Disconnect of TravelMate 610 notebook series.

UHCI/OHCI test utility:

1. Please prepare a USB device such as USB mouse, USB keyboard, USB floppy diskette or USB modem, and leave the USB ports disconnected.

NOTE: The diagnostic program will not be interrupted by disconnecting the USB diskette.

2. The program will dynamically detect the incoming device for 2 USB ports. Plug the USB connector on the first USB port, then un-plug it (connect at one time and disconnect at another time). To continue testing the second USB port, repeat the connect/disconnect procedure.

The testing program will show an account of connection/disconnection if every step is doing right. Consequently, a "PASS" message appears on the screen, otherwise, it displays "FAIL".

Smart Card Test

Insert Smart Card into the socket of the left panel. If it is doing well, the message "PASSED!!!" will be shown on the screen.

Infrared Ray (IR) Test

This function will test Infrared Ray of Acer TravelMate 610 series. Following are the steps:

1. Please prepare 2 machines. Choose "Test_program for Server" for one of the machines and choose "1" for Baud_Rate.
2. Choose "Test_program for Client" for the other machine.
3. Make the IR ports of the 2 machines close, then, after the detection between the two machines, the pass or fail message will appear on the screen.

Running PQA Diagnostics Program

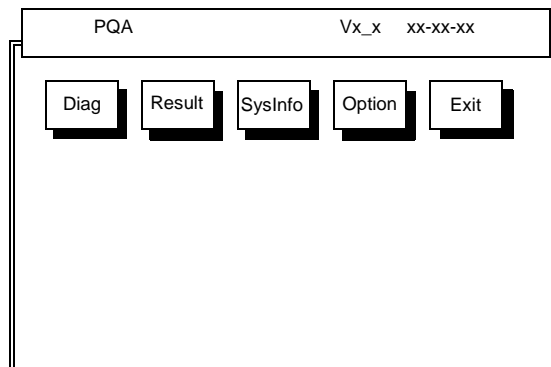

Press →← to move around the main menu. Press Enter to enable the selected option. The main options are Diag, Result, SysInfo, Option and Exit.

The Diag option lets you select testing items and times.

The following screen appears when you select Diag from the main menu.

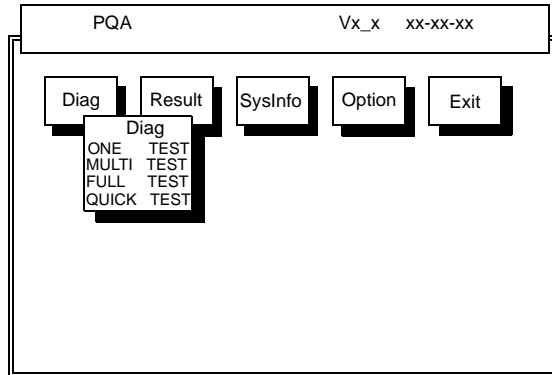

One Test performs a single test and Manual checks the selected test items in sequence.
 Multi Test performs multiple tests of the selected items and check the selected test items in sequence.
 Full Test performs all test items in detail for your system.
 Quick Test performs all test items quickly for your system.
 The screen below appears if you select MultiTest.

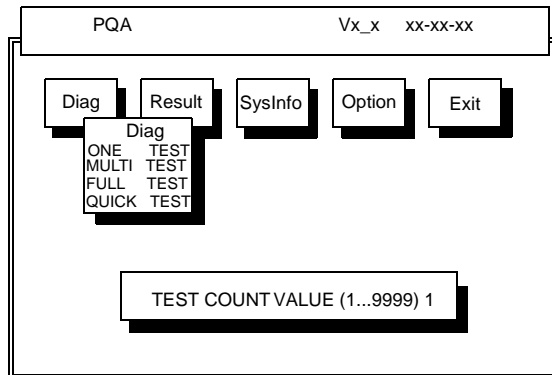

Specify the desired number of tests and press **Enter**.
 After you specify the number of tests to perform, the screen shows a list of test items (see below).

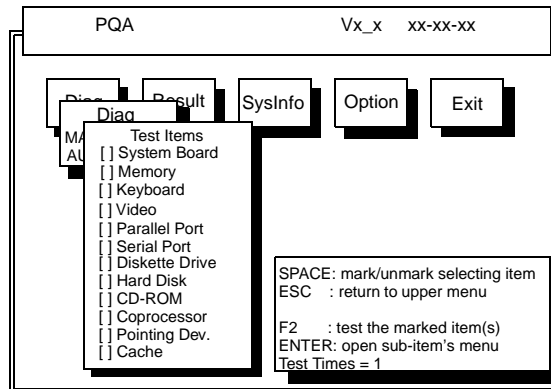

Move the highlight bar from one item to another. Press Space to enable or disable the item. Press **Enter** to view the available options of each selected item. Press **Esc** to close the submenu.

The right corner screen information gives you the available function keys and the specified test number.

- Space: Enables/disables the item
- ESC: Exits the program
- F1: Help
- F2: Tests the selected item(s)
- Enter: Opens the available options
- Test Times: Indicates the number of tests to perform.

NOTE: The F1 and F2 keys function only after you finish configuring the Test option.

NOTE: When any errors are detected by diagnostic program, refer to “Index of PQA Diagnostic Error Code, Message” on page 87 for troubleshooting.

Machine Disassembly and Replacement

This chapter contains step-by-step procedures on how to disassemble the notebook computer for maintenance and troubleshooting.

To disassemble the computer, you need the following tools:

- Wrist grounding strap and conductive mat to prevent electrostatic discharge
- Flat-bladed screwdriver
- Phillips screwdriver
- Hexagonal screwdriver
- Plastic stick

NOTE: The screws for the different components vary in size. During the disassembly process, group the screws with the corresponding components to avoid mismatches when putting back the components.

General Information

Before You Begin

Before proceeding with the disassembly procedure, make sure that you do the following:

1. Turn off the power to the system and all peripherals.
2. Unplug the AC adapter and all power and signal cables from the system.

Disassembly Procedure Flowchart

The flowchart on the succeeding page gives you a graphical representation on the entire disassembly sequence and instructs you on the components that need to be removed during servicing. For example, if you want to remove the system board, you must first remove the keyboard, then disassemble the inside assembly frame in that order.

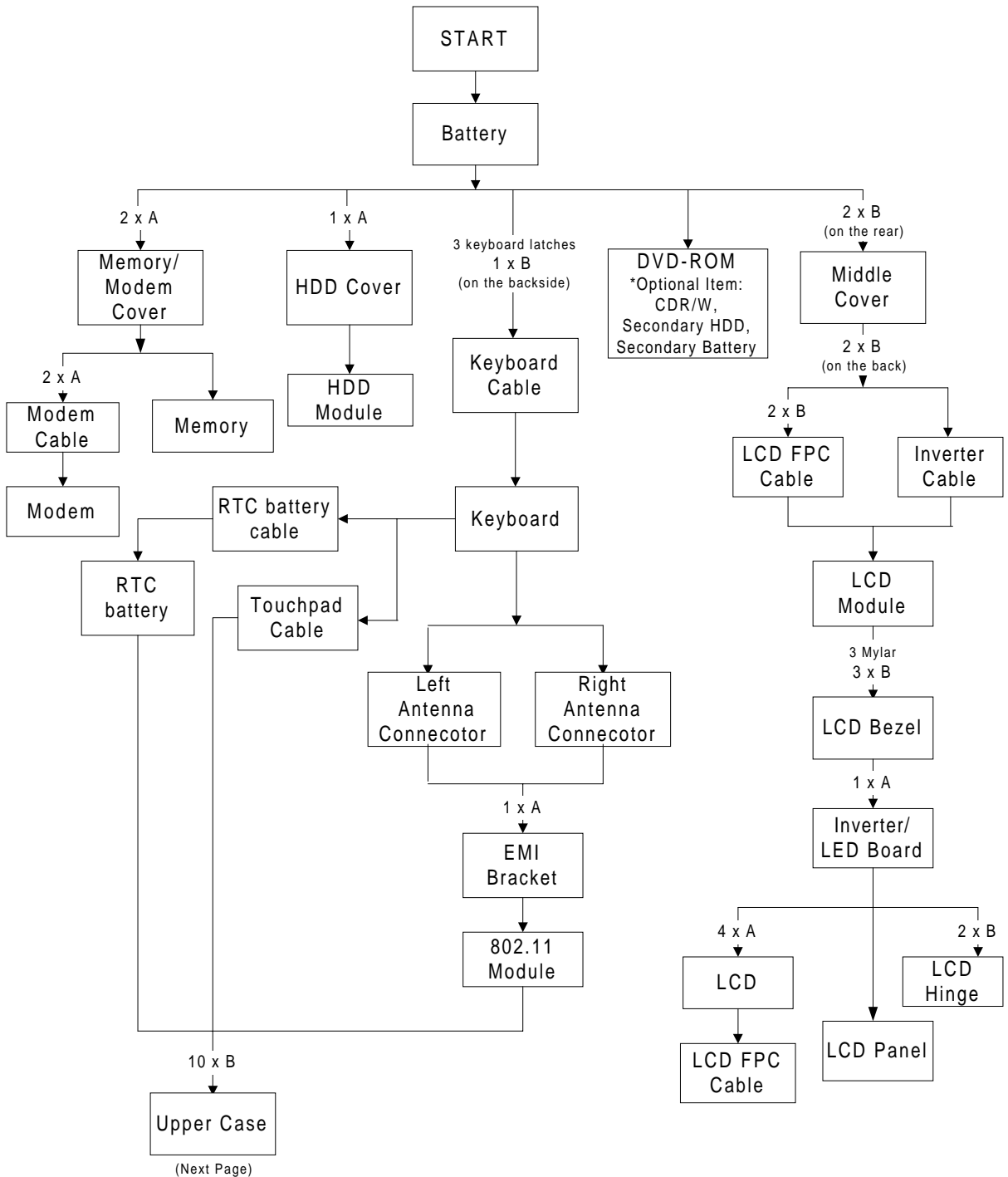

0k000007 Rev. 0A
CZ2 L
001114 Rev. A

Left
Antenna
Board

Right
Antenna
Board

0k000008 Rev. 0A
CZ2 R
001114 Rev. A

Fan Cable

4 x C
Thermal
Module

2 x B
Fan

Locker
CPU

Thermal
Charger
Bracket

1 x A
Microphone
Cable

Smart Card
FFC Cable

2 x A
Left
Speaker

2 x A
Right
Speaker

1 x A
Smart Card
Bracket

3 x A
HDD
Transfer
Board

Main board

Front Panel

Lower Case

Upper Case

Main Unit

Touchpad
Frame

Touchpad
Button

Touchpad

Scroll
Key

Screw List

Item	Part No.	Description
A	86.9A322.3R0	Screw M2 * 3
B	86.9A353.6R0	Screw M2.5 * 6
C	86.00938.220	CPU Screw

Removing the Battery Pack

1. To remove the battery pack, push the battery release button inward.
2. Slide the battery pack out of the machine.

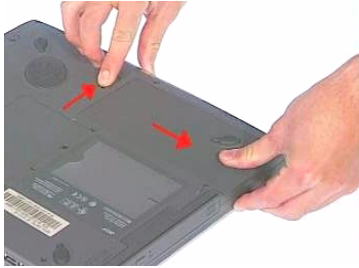

Removing the Hard disk drive Module

1. See “Removing the Battery Pack” on page 51
2. To remove the hard disk drive, first remove the screw from the hard disk drive bezel, then remove the cover.



3. Then carefully remove the hard disk drive module from the machine.



Disassembling the Hard disk drive Module

1. See “Removing the Battery Pack” on page 51
2. See “Removing the Hard disk drive Module” on page 52
3. Remove the two screws from back side of the hard disk drive module then slide the hard disk drive out from the hard disk drive out from the bracket .



-
4. Disconnect the connector from the hard disk drive module.



Removing the CD-ROM Drive Module

1. See “Removing the Battery Pack” on page 51
2. Push the CD-RW release button forward, then slide the CD-RW drive out from the machine at the same time.

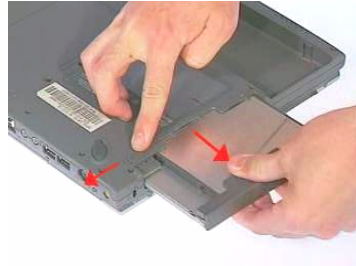

Disassembling the CD-ROM drive Module

1. See “Removing the Battery Pack” on page 51
2. See “Removing the CD-ROM Drive Module” on page 54
3. Remove the four screws, as shown, then detach the bracket from the CD-RW drive.

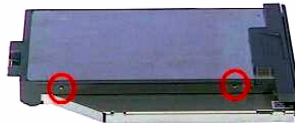
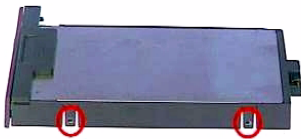

4. Remove the two screws then detach the CD-RW bay transfer board from the CD-RW drive.



Removing the Extended Memory

1. See “Removing the Battery Pack” on page 51
2. To remove the extended memory from the machine, first loosen two screws from the memory cover.
3. Then lift the cover off and remove it from the main unit.

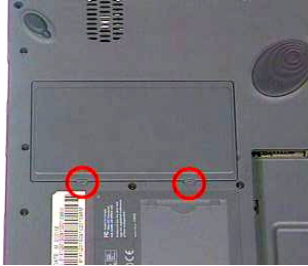

4. Push out the latches on both sides of the socket and pull the memory module from the socket.

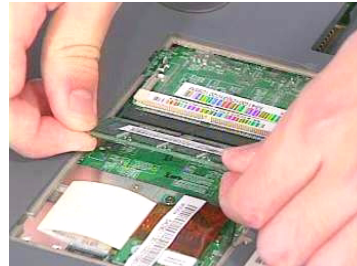
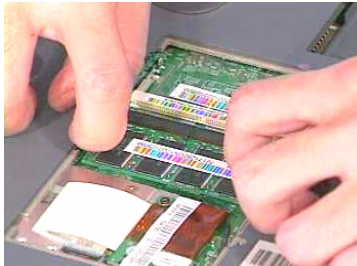

Removing the Modem Board

1. See “Removing the Battery Pack” on page 51
2. See “Removing the Extended Memory” on page 55
3. Remove two screws from the modem board and then remove the modem board from the main board at CN17.

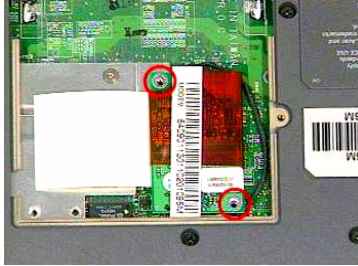

4. Disconnect the modem cable from the modem board carefully.

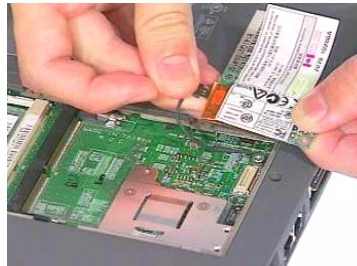

Disassembling the LCD

1. To avoid the risk of the LCD damage, we suggest you to place the protected Mylar film on the LCD surface before disassembly.

Removing the Middle Cover

1. See “Removing the Battery Pack” on page 51
2. To remove the middle cover, first remove the two screws from the middle cover on the rear panel.

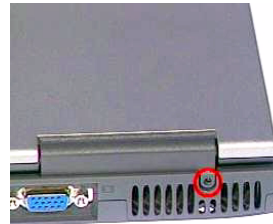

3. Push the LCD module to an angle of 135 degrees, as shown, to release the middle cover from left to right.



4. Pull the middle cover and lift it away.



Removing the Keyboard

1. See “Removing the Battery Pack” on page 51
2. See “Removing the Middle Cover” on page 57
3. To remove the keyboard, first remove the screw from the main unit.

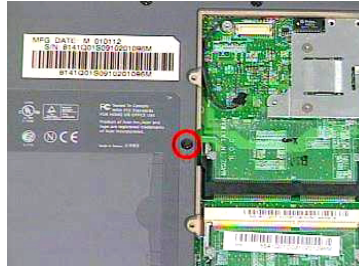

4. Pull the three latches downward to lift the keyboard upward and expose it.



5. Disconnect the keyboard cable from the main board at CN20, then carefully remove the keyboard from the main unit.

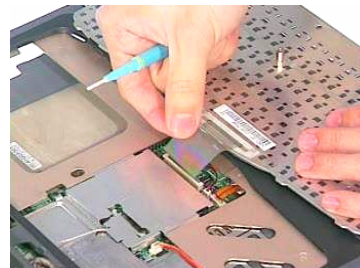
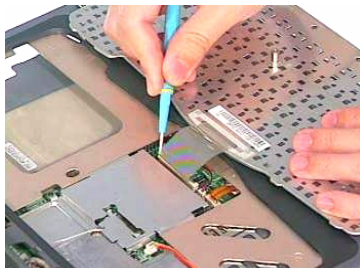

Removing the LCD Module

1. See “Removing the Battery Pack” on page 51
2. See “Removing the Middle Cover” on page 57
3. See “Removing the Keyboard” on page 58
4. Remove the two screws from the LCD FPC cable and then disconnect the LCD FPC cable from the mainboard.

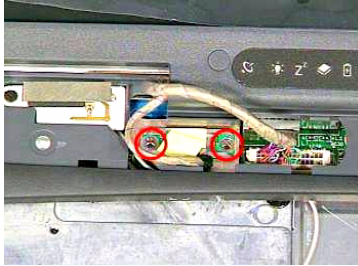

5. Disconnect the inverter cable from the main board at CN10.

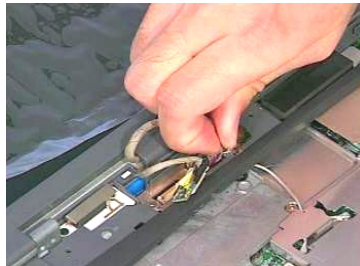

6. Remove the two screws from the backside of the unit as shown, and then remove the LCD module from the main unit.



Removing LCD Bezel

1. See “Removing the Battery Pack” on page 51
2. See “Removing the Middle Cover” on page 57
3. See “Removing the Keyboard” on page 58
4. See “Removing the LCD Module” on page 59
5. Remove three LCD plugs and then the three screws from the LCD bezel.



6. Snap off the LCD bezel carefully then remove the LCD bezel from the module.



Removing the Inverter/LED Board

1. See “Removing the Battery Pack” on page 51
2. See “Removing the Middle Cover” on page 57
3. See “Removing the Keyboard” on page 58
4. See “Removing the LCD Module” on page 59
5. See “Removing LCD Bezel” on page 60
6. To remove the inverter board, remove the screw from the inverter then detach it from the LCD panel.

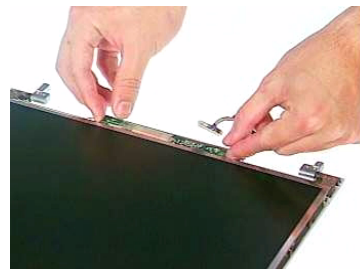
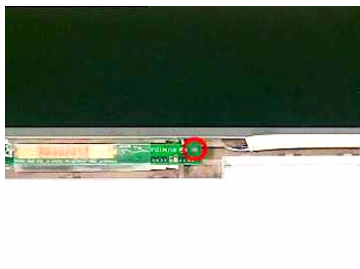

-
7. Disconnect the LCD power cable from the inverter.



8. Disconnect the inverter cable from the inverter.



Removing the LCD

1. See "Removing the Battery Pack" on page 51
2. See "Removing the Middle Cover" on page 57
3. See "Removing the Keyboard" on page 58
4. See "Removing the LCD Module" on page 59
5. See "Removing LCD Bezel" on page 60
6. See "Removing the Inverter/LED Board" on page 60
7. Remove four screws from both sides of the LCD.



8. Then remove the LCD from the LCD panel.



9. Gently remove the ESD tape and disconnect the LCD coaxial cable from the LCD.

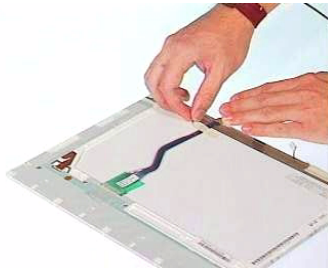

Removing the LCD Hinges

1. See "Removing the Battery Pack" on page 51
2. See "Removing the Middle Cover" on page 57
3. See "Removing the Keyboard" on page 58
4. See "Removing the LCD Module" on page 59
5. See "Removing LCD Bezel" on page 60
6. See "Removing the Inverter/LED Board" on page 60
7. See "Removing the LCD" on page 61
8. To remove the LCD hinges, first remove two screws from the LCD hinges.



-
9. Then remove the two LCD hinges from the LCD panel.

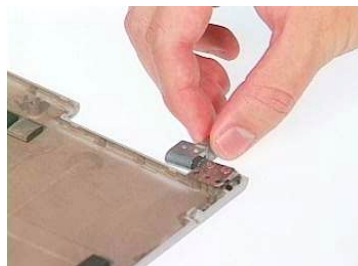
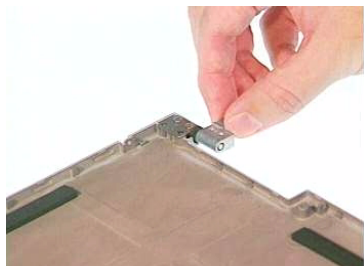

Disassembling the Upper Case

Removing the RTC Battery

1. See “Removing the Battery Pack” on page 51
2. See “Removing the Middle Cover” on page 57
3. See “Removing the Keyboard” on page 58
4. See “Removing the LCD Module” on page 59
5. Remove the RTC Battery from the main board gently.



Removing the LAN Board

1. See “Removing the Battery Pack” on page 51
2. See “Removing the Middle Cover” on page 57
3. See “Removing the Keyboard” on page 58
4. See “Removing the LCD Module” on page 59
5. To remove the LAN board, disconnect the left and right antenna connectors from the wireless LAN board carefully.

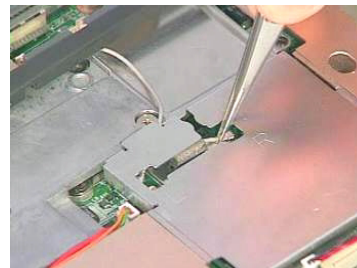
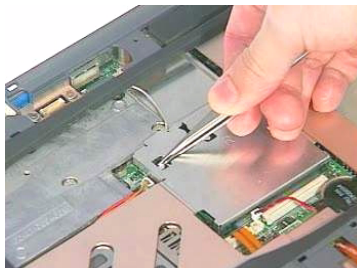

6. Remove the screw and then detach the EMI bracket from the main unit.

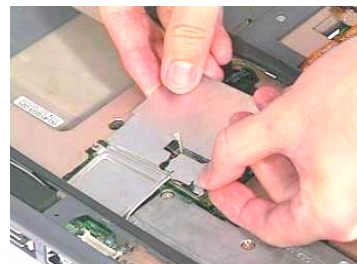
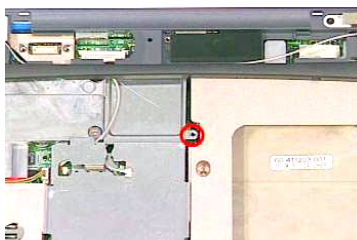

-
7. Remove the wireless LAN board from the main board.

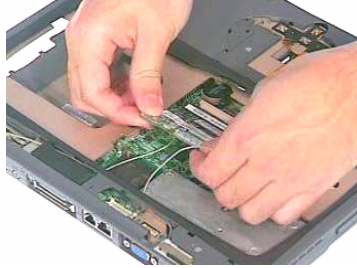

8. Disconnect the touchpad cable from the main board at CN18.

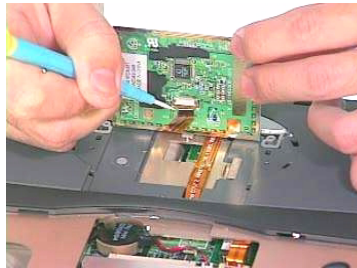

Removing the Upper Case

1. See "Removing the Battery Pack" on page 51
2. See "Removing the Middle Cover" on page 57
3. See "Removing the Keyboard" on page 58
4. See "Removing the LCD Module" on page 59
5. See "Removing the LAN Board" on page 64
6. To remove the upper case, first remove the eleven screws from the backside of the main unit.

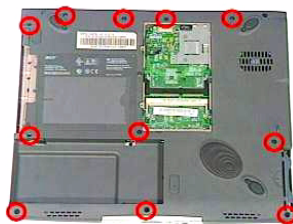

7. Then detach the upper case of the main unit carefully.

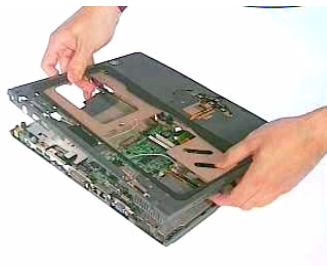

Disassembling the Lower Case

Removing the Smart Card Bracket

1. See “Removing the Battery Pack” on page 51
2. See “Removing the Middle Cover” on page 57
3. See “Removing the Keyboard” on page 58
4. See “Removing the LCD Module” on page 59
5. See “Removing the LAN Board” on page 64
6. See “Removing the Upper Case” on page 65
7. To remove the smart card bracket, first disconnect the smart card FPC cable from the HDD transfer board.

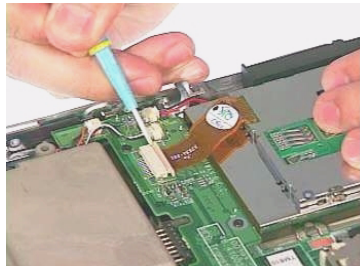

8. Remove two screws then detach the smart card bracket from the lower case.

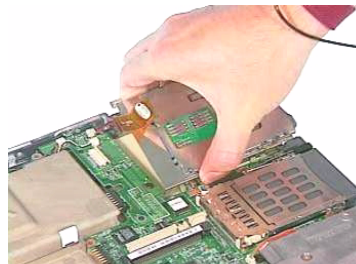
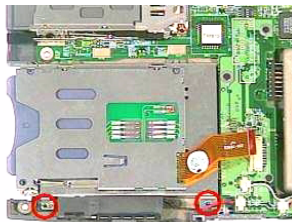

Removing the HDD Transfer Board

1. See “Removing the Battery Pack” on page 51
2. See “Removing the Middle Cover” on page 57
3. See “Removing the Keyboard” on page 58
4. See “Removing the LCD Module” on page 59
5. See “Removing the LAN Board” on page 64
6. See “Removing the Upper Case” on page 65
7. See “Removing the Smart Card Bracket” on page 66

-
8. To remove the HDD transfer board, first disconnect the right speaker cable and microphone cables from the HDD transfer board.

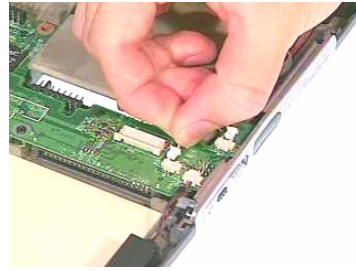
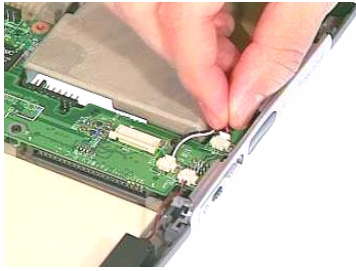

9. Disconnect the left cable from the HDD transfer board.

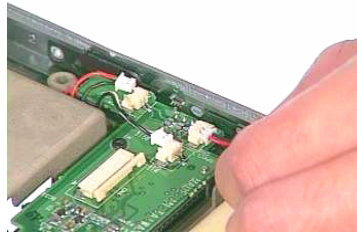

10. Remove three screws on the HDD transfer board from the main board and detach HDD transfer board.

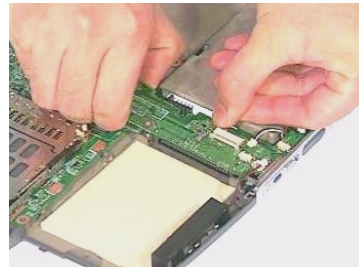
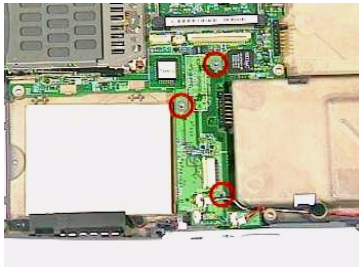

Removing the Microphone

1. See "Removing the Battery Pack" on page 51
2. See "Removing the Middle Cover" on page 57
3. See "Removing the Keyboard" on page 58
4. See "Removing the LCD Module" on page 59
5. See "Removing the LAN Board" on page 64
6. See "Removing the Upper Case" on page 65

-
7. Remove the microphone from the lower case.

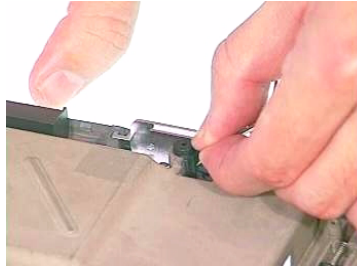

Removing the Speakers

1. See “Removing the Battery Pack” on page 51
2. See “Removing the Middle Cover” on page 57
3. See “Removing the Keyboard” on page 58
4. See “Removing the LCD Module” on page 59
5. See “Removing the LAN Board” on page 64
6. See “Removing the Upper Case” on page 65
7. Remove the two screws on the right speaker and one screw on the left speaker channel and detach the left and right speakers from the lower case.

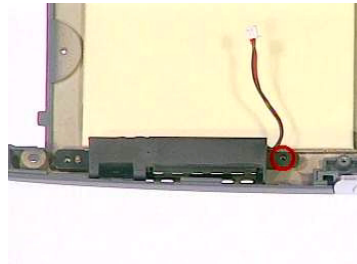
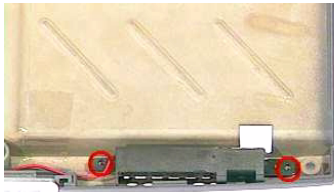

Removing the Front Panel

1. See “Removing the Battery Pack” on page 51
2. See “Removing the Middle Cover” on page 57
3. See “Removing the Keyboard” on page 58
4. See “Removing the LCD Module” on page 59
5. See “Removing the LAN Board” on page 64
6. See “Removing the Upper Case” on page 65

7. See “Removing the Smart Card Bracket” on page 66
8. See “Removing the HDD Transfer Board” on page 66
9. Remove the front panel from the lower case.



Removing the Fan

1. See “Removing the Battery Pack” on page 51
2. See “Removing the Middle Cover” on page 57
3. See “Removing the Keyboard” on page 58
4. See “Removing the LCD Module” on page 59
5. See “Removing the LAN Board” on page 64
6. See “Removing the Upper Case” on page 65
7. Disconnect the fan cable from the main board.

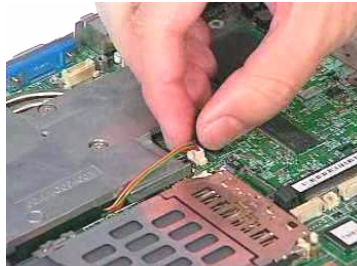

8. Remove the four screws then detach the thermal module from the main board.

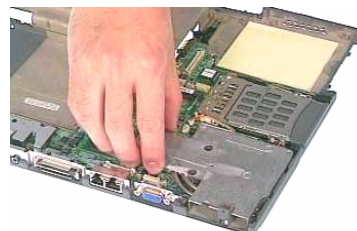
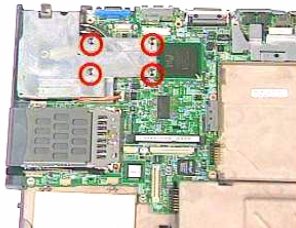

-
9. Remove the two screws then detach the fan from the thermal module.

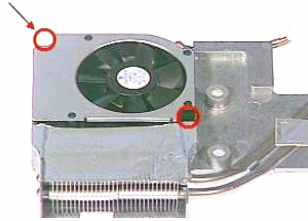

Removing the CPU

1. See “Removing the Battery Pack” on page 51
2. See “Removing the Middle Cover” on page 57
3. See “Removing the Keyboard” on page 58
4. See “Removing the LCD Module” on page 59
5. See “Removing the LAN Board” on page 64
6. See “Removing the Upper Case” on page 65
7. See “Removing the Fan” on page 69
8. To remove the CPU, use the flat screwdriver to release the screw carefully and then remove the CPU from the CPU socket.

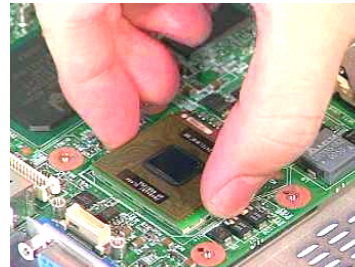
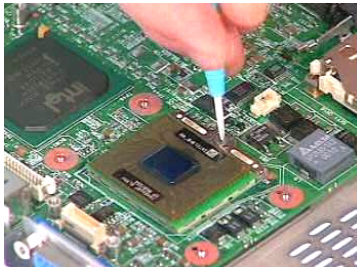

Removing the Thermal Charger Bracket

1. See “Removing the Battery Pack” on page 51
2. See “Removing the Middle Cover” on page 57
3. See “Removing the Keyboard” on page 58
4. See “Removing the LCD Module” on page 59
5. See “Removing the LAN Board” on page 64
6. See “Removing the Upper Case” on page 65

-
7. Remove the screw as shown here and then detach the thermal charger bracket from the main board.



Removing the Main board

1. See “Removing the Battery Pack” on page 51
2. See “Removing the Middle Cover” on page 57
3. See “Removing the Keyboard” on page 58
4. See “Removing the LCD Module” on page 59
5. See “Removing the LAN Board” on page 64
6. See “Removing the Upper Case” on page 65
7. See “Removing the HDD Transfer Board” on page 66
8. See “Removing the Fan” on page 69
9. See “Removing the CPU” on page 70
10. See “Removing the Thermal Charger Bracket” on page 70
11. Remove the main board from the lower case gently.

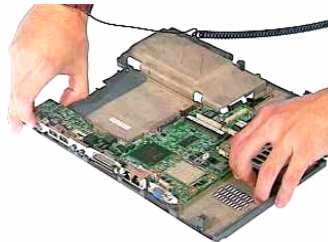

Removing the Antenna Boards

1. See “Removing the Battery Pack” on page 51
2. See “Removing the Middle Cover” on page 57
3. See “Removing the Keyboard” on page 58
4. See “Removing the LCD Module” on page 59
5. See “Removing the LAN Board” on page 64
6. See “Removing the Upper Case” on page 65

7. Remove the two screws as shown then detach the left and right antenna boards from the upper case.

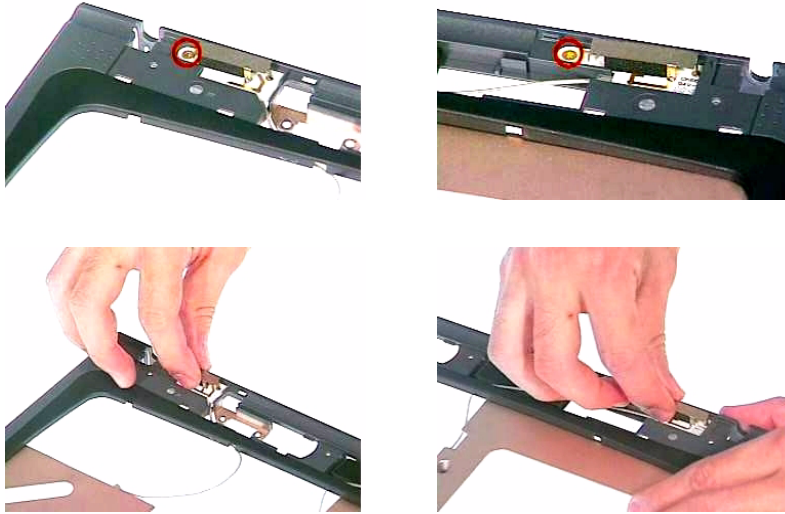

Removing the Touch Pad

1. See “Removing the Battery Pack” on page 51
2. See “Removing the Middle Cover” on page 57
3. See “Removing the Keyboard” on page 58
4. See “Removing the LCD Module” on page 59
5. See “Removing the LAN Board” on page 64
6. See “Removing the Upper Case” on page 65
7. Detach the touch pad frame from the upper case carefully then disconnect the touch pad cable from the touch pad board.

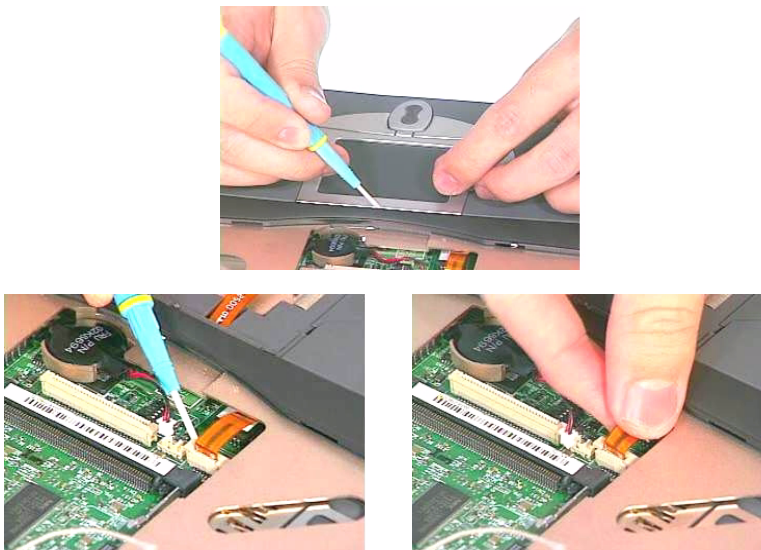

8. Remove the touch pad board from the upper case.

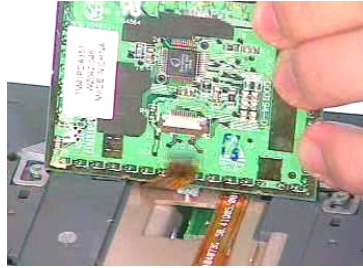

9. Remove the touch pad button and scroll key from the upper case.

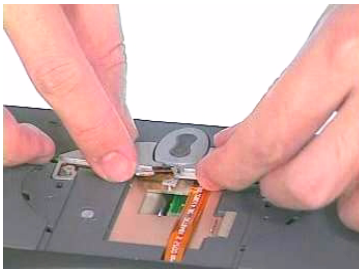

10. Then, remove the touch pad FPC cable from the upper case.

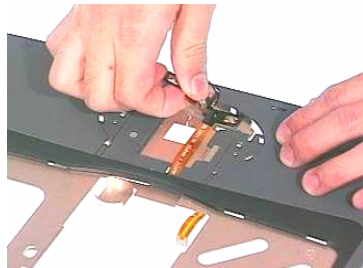

Troubleshooting

Use the following procedure as a guide for computer problems.

NOTE: The diagnostic tests are intended to test only Acer products. Non-Acer products, prototype cards, or modified options can give false errors and invalid system responses.

1. Obtain the failing symptoms in as much detail as possible.
2. Verify the symptoms by attempting to re-create the failure by running the diagnostic test or by repeating the same operation.
3. Use the following table with the verified symptom to determine which page to go to.

Symptoms (Verified)	Go To
Power failure. (The power indicator does not go on or stay on.)	"Power System Check" on page 77.
POST does not complete. No beep or error codes are indicated.	"Power-On Self-Test (POST) Error Message" on page 79 "Undetermined Problems" on page 86
POST detects an error and displayed messages on screen.	"Error Message List" on page 79
The diagnostic test detected an error and displayed a FRU code.	"Running PQA Diagnostics Program" on page 43
Other symptoms (i.e. LCD display problems or others).	"Power-On Self-Test (POST) Error Message" on page 79
Symptoms cannot be re-created (intermittent problems).	Use the customer-reported symptoms and go to "Power-On Self-Test (POST) Error Message" on page 79 "Intermittent Problems" on page 86 "Undetermined Problems" on page 86

System Check Procedures

External Diskette Drive Check

Do the following to isolate the problem to a controller, driver, or diskette. A write-enabled, diagnostic diskette is required.

NOTE: Make sure that the diskette does not have more than one label attached to it. Multiple labels can cause damage to the drive or cause the drive to fail.

Do the following to select the test device. See "Running PQA Diagnostics Program" on page 43 for details.

1. Boot from the diagnostics diskette and start the PQA program (See "Running PQA Diagnostics Program" on page 43).
2. Go to the diagnostic Diskette Drive in the test items.
3. Press F2 in the test items.
4. Follow the instructions in the message window.

If an error occurs with the internal diskette drive, reconnect the diskette connector on the main board.

If the error still remains:

1. Reconnect the external diskette drive/CD-ROM module.
2. Replace the external diskette drive/CD-ROM module.
3. Replace the main board.

External CD/DVD-ROM Drive Check

Do the following to isolate the problem to a controller, drive, or CD/DVD-ROM. Make sure that the CD/DVD-ROM does not have any label attached to it. The label can cause damage to the drive or can cause the drive to fail.

Do the following to select the test device:

1. Boot from the diagnostics diskette and start the PQA program (refer to "Running PQA Diagnostics Program" on page 43).
2. Go to the diagnostic CD/DVD-ROM in the test items.
3. Press F2 in the test items.
4. Follow the instructions in the message window.

If an error occurs, reconnect the connector on the main board. If the error still remains:

1. Reconnect the external diskette drive/CD/DVD-ROM module.
2. Replace the external diskette drive/CD/DVD-ROM module.
3. Replace the main board.

Keyboard or Auxiliary Input Device Check

Remove the external keyboard if the internal keyboard is to be tested.

If the internal keyboard does not work or an unexpected character appears, make sure that the flexible cable extending from the keyboard is correctly seated in the connector on the main board.

If the keyboard cable connection is correct, run the Keyboard Test. See "Running PQA Diagnostics Program" on page 43 for details.

If the tests detect a keyboard problem, do the following one at a time to correct the problem. Do not replace a non-defective FRU:

1. Reconnect the keyboard cables.
2. Replace the keyboard.
3. Replace the main board.

The following auxiliary input devices are supported by this computer:

- Numeric keypad
- External keyboard

If any of these devices do not work, reconnect the cable connector and repeat the failing operation.

Memory Check

Memory errors might stop system operations, show error messages on the screen, or hang the system.

1. Boot from the diagnostics diskette and start the PQA program (please refer to "Running PQA Diagnostics Program" on page 43).
2. Go to the diagnostic memory in the test items.
3. Press F2 in the test items.
4. Follow the instructions in the message window.

NOTE: Make sure that the DIMM is fully installed into the connector. A loose connection can cause an error.

Power System Check

To verify the symptom of the problem, power on the computer using each of the following power sources:

1. Remove the battery pack.
2. Connect the power adapter and check that power is supplied.
3. Disconnect the power adapter and install the charged battery pack; then check that power is supplied by the battery pack.

If you suspect a power problem, see the appropriate power supply check in the following list:

- "Check the Power Adapter" on page 77
- "Check the Battery Pack" on page 77

Check the Power Adapter

Unplug the power adapter cable from the computer and measure the output voltage at the plug of the power adapter cable. See the following figure

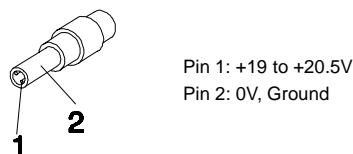

1. If the voltage is not correct, replace the power adapter.
2. If the voltage is within the range, do the following:
 - Replace the main board.
 - If the problem is not corrected, see "Undetermined Problems" on page 86.
 - If the voltage is not correct, go to the next step.

NOTE: An audible noise from the power adapter does not always indicate a defect.

3. If the power-on indicator does not light up, check the power cord of the power adapter for correct continuity and installation.
4. If the operational charge does not work, see "Check the Battery Pack" on page 77.

Check the Battery Pack

To check the battery pack, do the following:

1. Power off the computer.
2. Remove the battery pack and measure the voltage between battery terminals 1(ground) and 7(BT+). See the following figure

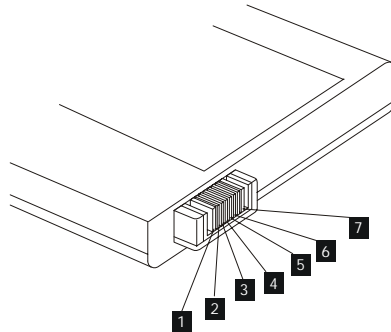

3. If the voltage is still less than 7.2 Vdc after recharging, replace the battery.

To check the battery charge operation, use a discharged battery pack or a battery pack that has less than 50% of the total power remaining when installed in the computer.

If the battery status indicator does not light up, remove the battery pack and let it return to room temperature. Re-install the battery pack.

If the charge indicator still does not light up, replace the battery pack. If the charge indicator still does not light up, replace the main board.

Touchpad Check

If the touchpad doesn't work, do the following actions one at a time to correct the problem. Do not replace a non-defective FRU:

1. Reconnect the touchpad cables.
2. Replace the touchpad.
3. Replace the main board.

After you use the touchpad, the pointer drifts on the screen for a short time. This self-acting pointer movement can occur when a slight, steady pressure is applied to the touchpad pointer. This symptom is not a hardware problem. No service actions are necessary if the pointer movement stops in a short period of time.

Power-On Self-Test (POST) Error Message

The POST error message index lists the error message and their possible causes. The most likely cause is listed first.

NOTE: Perform the FRU replacement or actions in the sequence shown in FRU/Action column, if the FRU replacement does not solve the problem, put the original part back in the computer. Do not replace a non-defective FRU.

This index can also help you determine the next possible FRU to be replaced when servicing a computer.

If the symptom is not listed, see “Undetermined Problems” on page 86.

The following lists the error messages that the BIOS displays on the screen and the error symptoms classified by function.

NOTE: Most of the error messages occur during POST. Some of them display information about a hardware device, e.g., the amount of memory installed. Others may indicate a problem with a device, such as the way it has been configured.

NOTE: If the system fails after you make changes in the BIOS Setup Utility menus, reset the computer, enter Setup and install Setup defaults or correct the error.

Index of Error Messages

Error Message List

Error Messages	FRU/Action in Sequence
Failure Fixed Disk	Reconnect hard disk drive connector. “Load Default Settings” in BIOS Setup Utility. Hard disk drive Main Board
Stuck Key	see “Keyboard or Auxiliary Input Device Check” on page 76 .
Keyboard error	see “Keyboard or Auxiliary Input Device Check” on page 76.
Keyboard Controller Failed	see “Keyboard or Auxiliary Input Device Check” on page 76.
Keyboard locked - Unlock key switch	Unlock external keyboard
Monitor type does not match CMOS - Run Setup	Run “Load Default Settings” in BIOS Setup Utility.
Shadow RAM Failed at offset: nnnn	BIOS ROM Main Board
System RAM Failed at offset: nnnn	DIMM Main Board
Extended RAM Failed at offset: nnnn	DIMM Main Board
System battery is dead - Replace and run Setup	Replace RTC battery and Run BIOS Setup Utility to reconfigure system time, then reboot system.
System CMOS checksum bad - Default configuration used	RTC battery Run BIOS Setup Utility to reconfigure system time, then reboot system.
System timer error	RTC battery Run BIOS Setup Utility to reconfigure system time, then reboot system. Main Board
Real time clock error	RTC battery Run BIOS Setup Utility to reconfigure system time, then reboot system. Main Board

Error Message List

Error Messages	FRU/Action in Sequence
Previous boot incomplete - Default configuration used	Run "Load Default Settings" in BIOS Setup Utility. RTC battery Main Board
Memory size found by POST differed from CMOS	Run "Load Default Settings" in BIOS Setup Utility. DIMM Main Board
Diskette drive A error	Check the drive is defined with the proper diskette type in BIOS Setup Utility See "External Diskette Drive Check" on page 76.
Incorrect Drive A type - run SETUP	Check the drive is defined with the proper diskette type in BIOS Setup Utility See "External Diskette Drive Check" on page 76.
System cache error - Cache disable	Main Board
CPU ID:	Main Board
DMA Test Failed	DIMM Main Board
Software NMI Failed	DIMM Main Board
Fail-Safe Timer NMI Failed	DIMM Main Board
Device Address Conflict	Run "Load Default Settings" in BIOS Setup Utility. RTC battery Main Board
Allocation Error for device	Run "Load Default Settings" in BIOS Setup Utility. RTC battery Main Board
Failing Bits: nnn	DIMM BIOS ROM Main Board
Fixed Disk n	None
Invalid System Configuration Data	BIOS ROM Main Board
I/O device IRQ conflict	Run "Load Default Settings" in BIOS Setup Utility. RTC battery Main Board
Operating system not found	Enter Setup and see if fixed disk and drive A: are properly identified. Diskette drive Hard disk drive Main Board

Index of Symptom-to-FRU Error Message

Error Message List

No beep Error Messages	FRU/Action in Sequence
No beep, power-on indicator turns off and LCD is blank.	Power source (battery pack and power adapter). See "Power System Check" on page 77. Ensure every connector is connected tightly and correctly. Reconnect the DIMM. LED board. Main Board.
No beep, power-on indicator turns on and LCD is blank.	Power source (battery pack and power adapter). See "Power System Check" on page 77. Reconnect the LCD connector Hard disk drive LCD inverter I LCD cabl LCD Inverter LCD Main Board
No beep, power-on indicator turns on and LCD is blank. But you can see POST on an external CRT.	Reconnect the LCD connectors. LCD inverter I LCD cable LCD inverter LCD Main Board
No beep, power-on indicator turns on and a blinking cursor shown on LCD during POST.	Ensure every connector is connected tightly and correctly. Main Board
No beep during POST but system runs correctly.	Speake Main Board

Index of Symptom-to-FRU Error Message

No beep Error Messages	FRU/Action in Sequence
No beep, power-on indicator turns off and LCD is blank.	Power source (battery pack and power adapter). See "Power System Check" on page 77. Ensure every connector is connected tightly and correctly. Reconnect the DIMM. LED board. Main Board.
No beep, power-on indicator turns on and LCD is blank.	Power source (battery pack and power adapter). See "Power System Check" on page 77. Reconnect the LCD connector Hard disk drive LCD inverter I LCD cabl LCD Inverter LCD Main Board
No beep, power-on indicator turns on and LCD is blank. But you can see POST on an external CRT.	Reconnect the LCD connectors. LCD inverter I LCD cable LCD inverter LCD Main Board
No beep, power-on indicator turns on and a blinking cursor shown on LCD during POST.	Ensure every connector is connected tightly and correctly. Main Board
No beep during POST but system runs correctly.	Speake Main Board

LCD-Related Symptoms

Symptom / Error	Action in Sequence
LCD backlight doesn't work LCD is too dark LCD brightness cannot be adjusted LCD contrast cannot be adjusted	Enter BIOS Utility to execute "Load Setup Default Settings", then reboot system. Reconnect the LCD connectors. Keyboard (if contrast and brightness function key doesn't work). LCD inverter I LCD cabl LCD inverter LCD Main Board
Unreadable LCD screen Missing pels in characters Abnormal screen Wrong color displayed	Reconnect the LCD connector LCD inverter I LCD cabl LCD inverter LCD Main Board

LCD-Related Symptoms

Symptom / Error	Action in Sequence
LCD has extra horizontal or vertical lines displayed.	LCD inverter I LCD inverter LCD cabl LCD Main Board

Indicator-Related Symptoms

Symptom / Error	Action in Sequence
Indicator incorrectly remains off or on, but system runs correctly	Reconnect the inverter board Inverter board Main Board

Power-Related Symptoms

Symptom / Error	Action in Sequence
Power shuts down during operation	Power source (battery pack and power adapter). See "Power System Check" on page 77. Battery pack Power adapter Hard drive & battery connection board Main Board
The system doesn't power-on.	Power source (battery pack and power adapter). See "Power System Check" on page 77. Battery pack Power adapter Hard drive & battery connection board Main Board
The system doesn't power-off.	Power source (battery pack and power adapter). See "Power System Check" on page 77. Hold and press the power switch for more than 4 seconds. Main Board
Battery can't be charged	See "Check the Battery Pack" on page 77. Battery pack Main Board

PCMCIA/Smart Card-Related Symptoms

Symptom / Error	Action in Sequence
System cannot detect the PC Card (PCMCIA)	PCMCIA/Smart Card slot assembly Main Board
System cannot detect the Smart Card	Smart Card PCMCIA/Smart Card slot assembly Main Board
PCMCIA/Smart Card slot pin is damaged.	PCMCIA/Smart Card slot assembly

Memory-Related Symptoms

Symptom / Error	Action in Sequence
Memory count (size) appears different from actual size.	Enter BIOS Setup Utility to execute "Load Default Settings, then reboot system. DIMM Main Board

Speaker-Related Symptoms

Symptom / Error	Action in Sequence
In Windows, multimedia programs, no sound comes from the computer.	Audio driver Speake Main Board
Internal speakers make noise or emit n sound.	Speake Main Board

Power Management-Related Symptoms

Symptom / Error	Action in Sequence
The system will not enter hibernation	Keyboard (if control is from the keyboard) Hard disk drive Main Board
The system doesn't enter hibernation mode and four short beeps every minute.	See "Hibernation Mode" on page 24. Press Fn+F4 and see if the computer enters hibernation mode. Touchpad Keyboard Hard disk connection boar Hard disk drive Main Board
The system doesn't enter standby mode after closing the LCD	See "Standby Mode" on page 24. LCD cover switch Main Board
The system doesn't resume from hibernation mode.	See "Hibernation Mode" on page 24. Hard disk connection boar Hard disk drive Main Board
The system doesn't resume from standby mode after opening the LCD.	See "Standby Mode" on page 24. LCD cover switch Main Board
Battery fuel gauge in Windows doesn't go higher than 90%.	Remove battery pack and let it cool for 2 hours. Refresh battery (continue use battery until power off, then charge battery). Battery pack Main Board
System hangs intermittently.	See "Thermal and Fan Utility" on page 40. Reconnect hard disk/CD-ROM drives. Hard disk connection boar Main Board

Peripheral-Related Symptoms

Symptom / Error	Action in Sequence
System configuration does not match the installed devices.	Enter BIOS Setup Utility to execute "Load Default Settings", then reboot system. Reconnect hard disk/CD-ROM/diskette drives.
External display does not work correctly.	Press Fn+F5, LCD/CRT/Both display switching See "Running PQA Diagnostics Progra " on page 43. Main Board
USB does not work correctly	See "Running PQA Diagnostics Progra " on page 43 Main Board

Peripheral-Related Symptoms

Symptom / Error	Action in Sequence
Print problems.	Ensure the "Parallel Port" in the "Onboard Devices Configuration" of BIOS Setup Utility is set to Enabled. Onboard Devices Configuration Run printer self-test. Printer driver Printer cable Printer Main Board
Serial or parallel port device problems.	Ensure the "Serial Port" in the Devices Configuration" of BIOS Setup Utility is set to Enabled. Device driver Device cable Device Main Board

Keyboard/Touchpad-Related Symptoms

Symptom / Error	Action in Sequence
Keyboard (one or more keys) does not work.	Reconnect the keyboard cable. Keyboard Main Board
Touchpad does not work.	Reconnect touchpad cable. Touchpad board Main Board

Modem-Related Symptoms

Symptom / Error	Action in Sequence
Internal modem does not work correctly.	modem board Main Board

NOTE: If you cannot find a symptom or an error in this list and the problem remains, see "Undetermined Problems" on page 86.

LAN-Related Symptoms

Symptom / Error	Action in Sequence
Internal LAN does not work correctly.	LAN board Main Board

Wireless LAN-Related Symptoms

Symptom / Error	Action in Sequence
Internal wireless LAN does not work correctly.	right or left antenna kits wireless LAN board Main Board

Intermittent Problems

Intermittent system hang problems can be caused by a variety of reasons that have nothing to do with a hardware defect, such as: cosmic radiation, electrostatic discharge, or software errors. FRU replacement should be considered only when a recurring problem exists.

When analyzing an intermittent problem, do the following:

1. Run the advanced diagnostic test for the main board in loop mode at least 10 times.
2. If no error is detected, do not replace any FRU.
3. If any error is detected, replace the FRU. Rerun the test to verify that there are no more errors.

Undetermined Problems

The diagnostic problems does not identify which adapter or device failed, which installed devices are incorrect, whether a short circuit is suspected, or whether the system is inoperative.

Follow these procedures to isolate the failing FRU (do not isolate non-defective FRU).

NOTE: Verify that all attached devices are supported by the computer.

NOTE: Verify that the power supply being used at the time of the failure is operating correctly. (See "Power System Check" on page 77):

1. Power-off the computer.
2. Visually check them for damage. If any problems are found, replace the FRU.
3. Remove or disconnect all of the following devices:
 - Non-Acer devices
 - Printer, mouse, and other external devices
 - Battery pack
 - Hard disk drive
 - DIMM
 - CD-ROM/Floppy diskette drive Module
 - PC Cards
4. Power-on the computer.
5. Determine if the problem has changed.
6. If the problem does not recur, reconnect the removed devices one at a time until you find the failing FRU.
7. If the problem remains, replace the following FRU one at a time. Do not replace a non-defective FRU:
 - Main Board
 - LCD assembly

Index of AFlash BIOS Error Message

Error Message	Action in Sequence
Hardware Error	See "System Diagnostic Diskette" on page 42
VPD Checksum Error	Reboot the system and then restart with this diskette.
BIOS Update Program Error	Turn off the power and restart the system.
System Error	Make sure this AFlash BIOS diskette for this model.
Without AC adapter	make sure to connect AC adapter
Battery Low	make sure to install a highly charged battery, and reboot system.

Index of PQA Diagnostic Error Code, Message

Error Code	Message	Action in Sequence
16XXX	Backup battery error	Backup battery
01XXX	CPU or main board error	Reload BIOS default setting. Main Board
02XXX	Memory error	DIM Main Board
03XXX	Keyboard error	Reset Keyboard Keyboard Main Board
04XXX	Video error	Main Board
05XXX	Parallel Port error	Main Board
06XXX	Serial port or main board error	Main Board
07XXX	Diskette drive error	Diskette drive Main Board
08XXX	Hard disk error	Reload BIOS default setting Hard disk Main Board
09XXX	CD-ROM error	Reset CD-ROM cable CD-ROM drive Main Board
10XXX	Co-processor error	Main Board
11XXX	Pointing device error	Reset Keyboard Keyboard Main Board
12XXX	Cache test error	Main Board

Jumper and Connector Information

Mainboard Top View

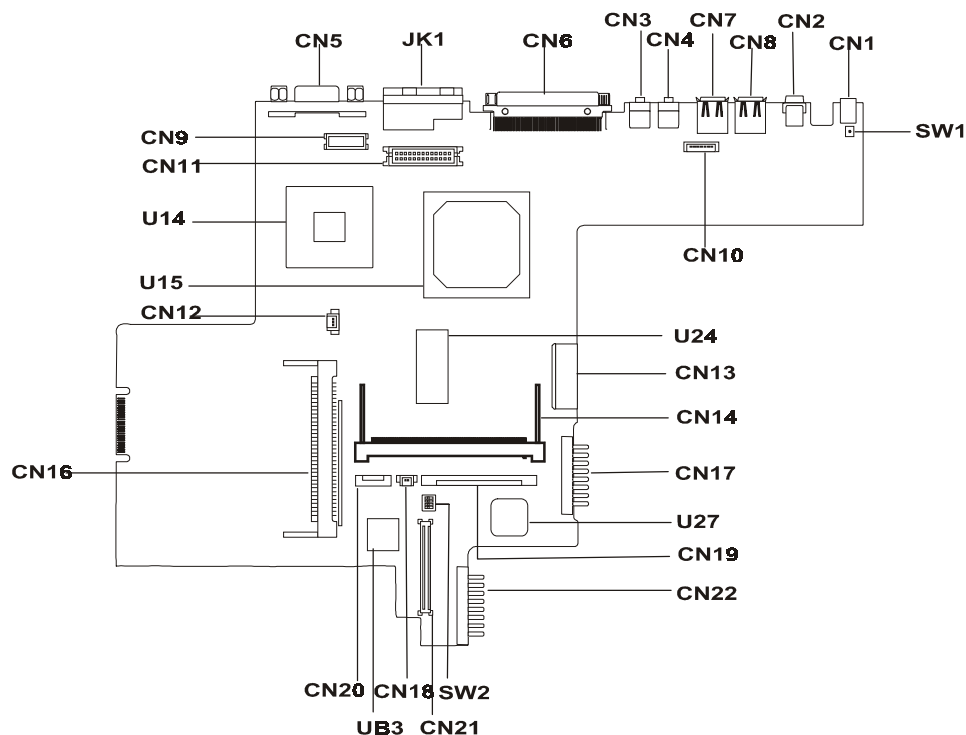

PCB 99203

Item	Description	Item	Description
CN1	AC Adapter Connector	CN17	Secondary Battery Connector
CN2	PS/2 Port	CN18	RTC Battery Connector
CN3	Line-out port	CN19	Internal Keyboard Connector
CN4	Line-in/ MIC-in port	CN20	Touchpad Connector
CN5	Video Port	CN21	HDD Board Connector
CN6	Port Replicator	CN22	Primary Battery Connector
CN7	USB 0 Port	JK1	LAN/Modem Connector
CN8	USB 0 Port	SW1	Cover Switch
CN9	LCD Connector	SW2	Mainboard Setting
CN10	BlueTooth Connector	UB3	BIOS ROM
CN11	LED/Inverter Board Connector	U14	CPU Socket
CN12	FAN Connecto	U15	North Bridge (GMCH2M)
CN13	Bay Connector	U24	Display Cache
CN14	Mini PCI Card Connecto	U27	KBC/Super I/O

PCB 99203

Item	Description	Item	Description
CN16	PCMCIA Socket		

SW2 Settings

SW2	Setting
Switch 1, Switch 8	*OFF: Acer BIOS ON: OEM BIOS
Switch 2, Switch 7	*OFF: KBC BIOS Protected ON: KBC BIOS Unprotected
Switch 3, Switch 6	*OFF: Check password ON: Bypass password
Switch 4, Switch 5	BootBlock OFF: Disable *ON: Enable to write

NOTE: * is the default setting.

Mainboard Bottom View

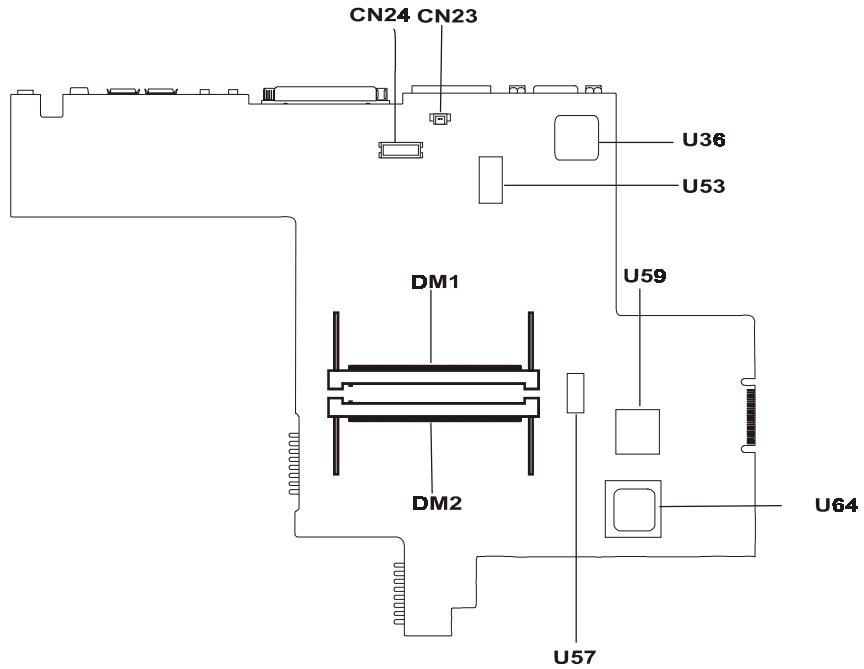

Item	Description	Item	Description
CN23	Modem Cable Connecto	U53	LAN Controlle
CN24	Modem Board Connector	U57	Clock Generator Controller
DM1	DIMM Socket 1	U59	Card Bus Controlle
DM2	DIMM Socket 2	U64	South Bridge
U36	VCH Controller		

Hard Disk Transfer Board Top view

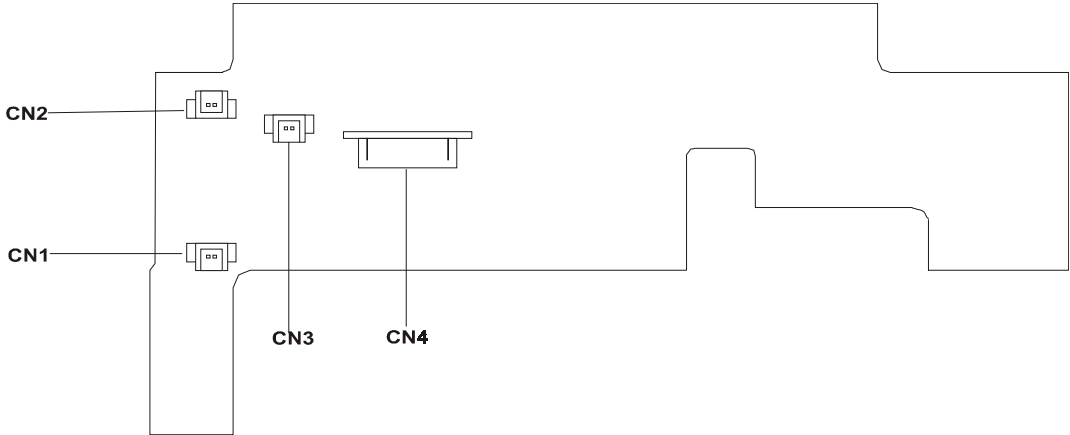

Item	Description	Item	Description
CN1	Right Speaker	CN3	Microphone Cable Connector
CN2	Left Speaker	CN4	HDD Transfer Board Cable Connector

Hard Disk Transfer Board Bottom view

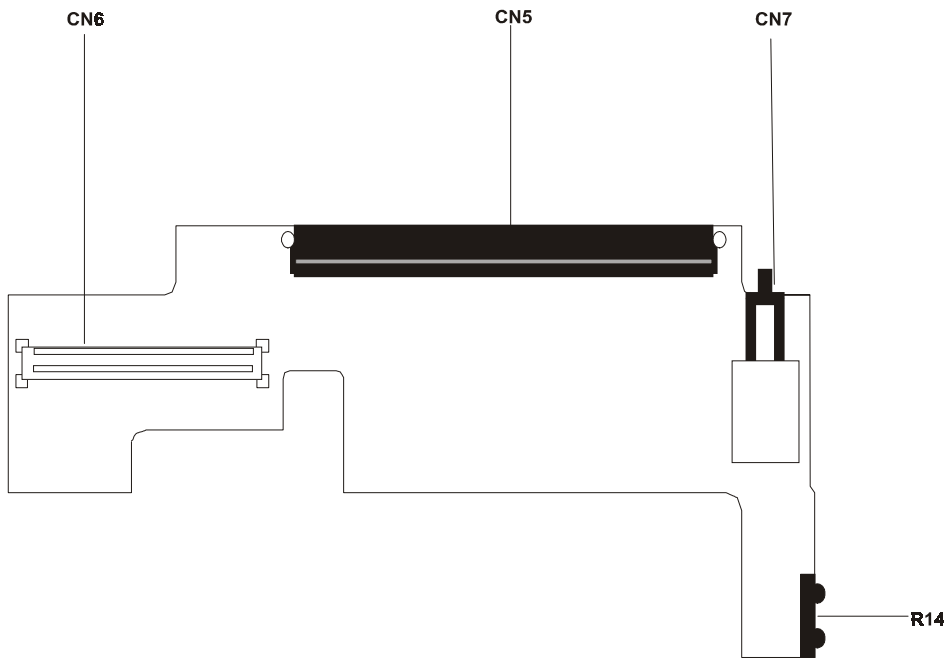

Item	Description	Item	Description
CN5	Hard Disk Driver Connector	CN7	Power Switch
CN6	Hard Disk Driver Board Connector	R14	FIR Port

FRU (Field Replaceable Unit) List







This chapter gives you the FRU (Field Replaceable Unit) listing in global configurations of TravelMate 610. Refer to this chapter whenever ordering for parts to repair or for RMA (Return Merchandise Authorization).

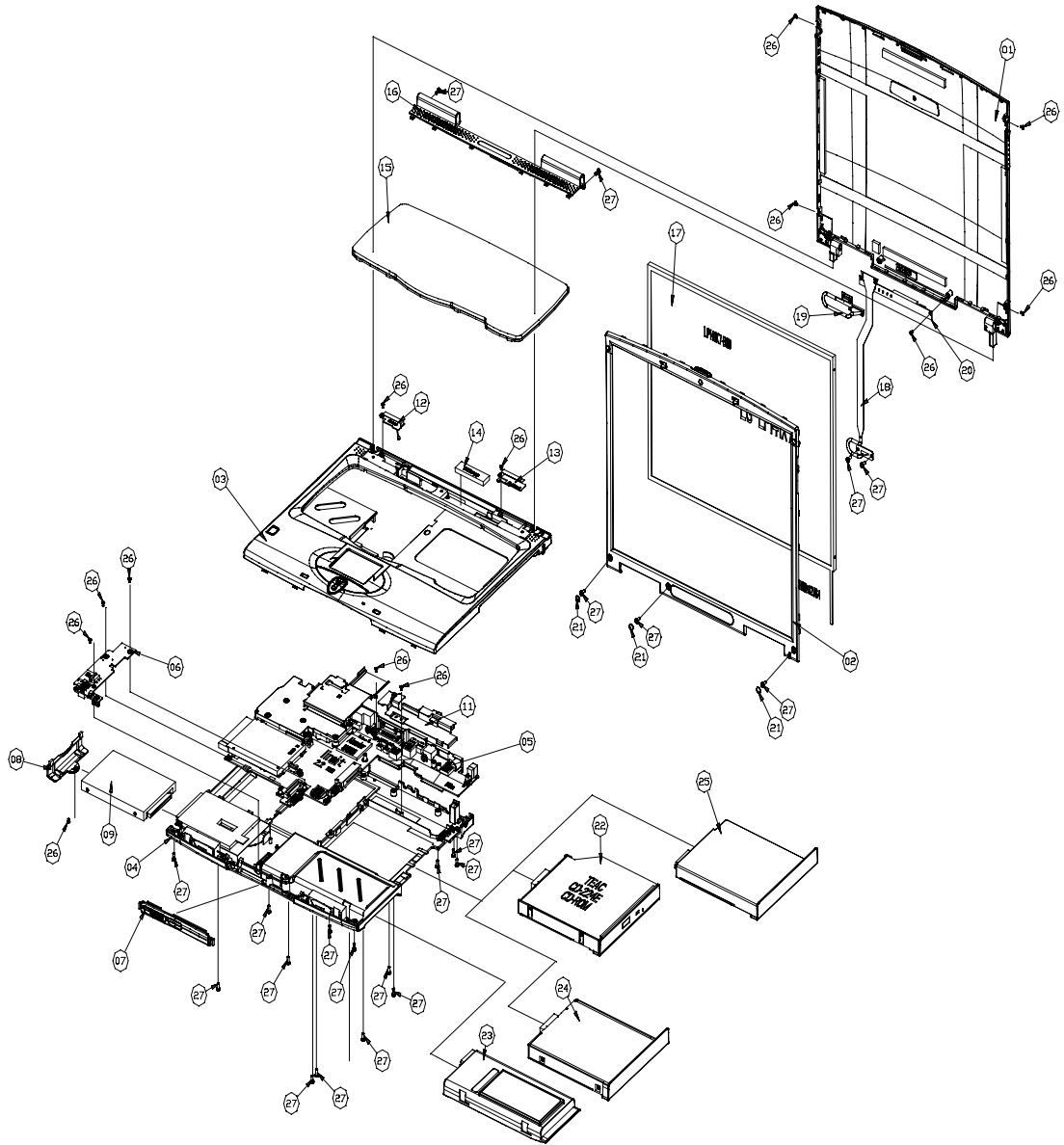

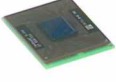

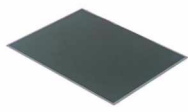
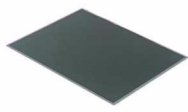
IMPORTANT: Please note WHEN ORDERING FRU PARTS, that you should check the most up-to-date information available on your regional web or channel. For whatever reasons a part number change is made, it will not be noted in the printed Service Guide. For ACER-AUTHORIZED SERVICE PROVIDERS, your Acer office may have a DIFFERENT part number code to those given in the FRU list of this printed Service Guide. You MUST use the local FRU list provided by your regional Acer office to order FRU parts for repair and service of customer machines.

NOTE: To scrap or to return the defective parts, you should follow the local government ordinance or regulations on how best to dispose it, or follow the rules set by your regional Acer office on how to return it.

NOTE: The number indicates the location shown on exploded diagram or “NS” indicates “Not shown” on it.

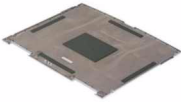
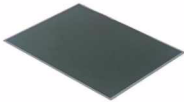
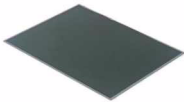

Picture	No.	Partname	Description	Part No.
CPU				
	NS	CPU COPPERMINE PIII 850MHZ 256K INTEL	IC CPU COP850/256 OD 1.6 UPGA2	01.COPRM.85
		CPU COPPERMINE PIII 800MHZ 257K INTEL	IC CPU COP800/256 OD 1.6 UPGA2	01.COPRM.80I
Memory				
	NS	MEMORY SDIMM 128 MITSUBISHI	SDIMM 128 MH16S64AVS-7TA	72.16S64.C0N
		MEMORY SDIMM 128M NEC	SODIMM 128MB W17128AHNC8602A	72.17128.D0N
LCD				
	17	LCD MODULE 14.1" XGA TM610	14.1"LCD_MODULE 610	6M.41Q07.001
	17	LCD 14.1"XGA IBM/ITXG77	LCD 14.1"XGA IBM/ ITXG77	56.0741Q.011
	2	LCD BEZEL	14.1" BEZEL_MODULE 610	60.41Q07.00
	18	LCD CABLE	610-14.1" LCD_COAXIAL_CABLE	50.41Q02.00
	NS	LCD HINGE LEFT	610_HINGE-L	34.41Q05.00



Picture	No.	Partname	Description	Part No.
	NS	LCD HINGE RIGHT	610_HINGE-R	34.41Q04.00
	20	LCD INVERTER	INVERTER 14" IV09117T V.1 610	19.21030.D51
	1	LCD PANEL	14.1"LCD_PANNEL_MOD ULE 610	60.41Q05.00
	NS	LCD RUBBER	CSN LCD RUBBER 520	47.41C03.001
	NS	LCD RUBBER CAMERA	RUBBER CAMERA TM340	47.40F07.002
	26	LCD SCREW M2*L3	SCRW BIND M2*L3 B-ZN SHIVA	86.9A322.3R0
	27	LCD SCREW M2.5X6	SCREW M2.5X6	86.9A353.6R0
	21	LCD SCREW MYLAR	MYLAR_SCREW_BEZEL_610	40.41Q05.00
	NS	LCD WIRE CABLE	610_LCD-WIRE_CABLE	50.41Q01.00
	17	LCD MODULE 14.1" XGA TM610	ASSY LG 14.1"LCD_MODULE 610	6M.41Q07.011
	17	LCD 14.1"XGA LG/LP141X7	LCD 14.1"XGA LG/ LP141X7	56.0741Q.00
	2	LCD BEZEL	14.1"BEZEL_MODULE 610	60.41Q07.00



Picture	No.	Partname	Description	Part No.
	18	LCD CABLE	C.A. COAXIAL 18/20PIN(F	50.41Q08.00
	NS	LCD HINGE LEFT	610_HINGE-L	34.41Q05.00
	NS	LCD HINGE RIGHT	610_HINGE-R	34.41Q04.00
	20	INVERTER	INVERTER 13" T621194.00	19.21030.D61
	1	LCD PANEL	14.1" LCD_PANNEL_MODULE	60.41Q05.00
	NS	LCD RUBBER	CSN LCD RUBBER 520	47.41C03.001
	NS	LCD RUBBER CAMERA	RUBBER CAMERA TM340	47.40F07.002
	26	LCD SCREW M2*L3	SCRW BIND M2*L3 B-ZN SH	86.9A322.3R0
	27	LCD SCREW M2.5X6	SCREW M2.5X6	86.9A353.6R0
	21	LCD SCREW MYLAR	MYLAR_SCREW_BEZEL_ 610	40.41Q05.00
	NS	LCD WIRE CABLE	610_LCD-WIRE_CABLE	50.41Q01.00
FDD/Floppy Disk Drive				
	NS	FDD SLIM USB	FDD MDL SLIM USB YD- 8U10 M861P	90.42F05.002
		FDD SLIM USB	FDD USB SINGLE YD- 8U10 M861P	90.42F05.012

Picture	No.	Partname	Description	Part No.
HDD/Hard Disk Drive				
	09	HDD MODULE 20G TM610	ASSY HDD_MODULE HTC 20G T2-610	6M.41Q13.001
		HDD 20G 9.5MM HITACHI/ DK23BA-20	HDD 20GB 9.5MM HIT/ DK23BA-20	56.02B32.081
	NS	HDD SKT	SKT 44P HDD 20120S-44/ 4	22.10243.011
	NS	HDD PLATE	ASSY_HDD-PLATE_610	60.41Q10.00
CD-ROM Drive				
	22	CD-RW MODULE 8X4X24X TM 610	CDRW-ROM_MODULE 610	6M.41Q06.001
	NS	CD/DVD ROM SCREW	SCRW BIND M2*L3 B-ZN SHIVA	86.9A322.3R0
	NS	CD/DVD ROM SPECIAL SCREW	CD-ROM SPECIAL SCREW	86.00A19.120
	NS	CD-RW 8X4X 24X KME/ UJDA330	CD-RW 8X4X24X KME/ UJDA330AC610	56.19047.001
	NS	CD-ROM CHASSIS	ASSY_CD ROM_CHASSIS_610	60.41Q12.00
	NS	CD-ROM BOARD	T2-610CD-ROMBOARD	55.41Q03.00
DVD-ROM Drive				
	22	DVD-ROM MODULE 8X TM610	DVD-ROM_MODULE 610	6M.41Q05.001
	NS	CD/DVD ROM SCREW	SCRW BIND M2*L3 B-ZN SH	86.9A322.3R0
	NS	CD/DVD ROM SPECIAL SCREW	CD-ROM SPECIAL SCREW	86.00A19.120
	NS	DVD-ROM BEZEL	ASSY_DVD- ROM_BEZEL_611	60.41Q14.00

Picture	No.	Partname	Description	Part No.
	NS	CD-ROM CHASSIS	ASSY_CD ROM_CHASSIS_61	60.41Q12.00
	NS	DVD-ROM 8X TOSHIBA/SD-C2502	DVD 8X TOSHIBA/SD-C2502	56.2249C.021
	NS	CD-ROM BOARD	T2-610 CD-ROM BOARD	55.41Q03.00
Heat Sink				
	NS	HEATSINK	ASSY_CPU_HEAT_PIPE_610	60.41Q02.00
Fan				
	NS	FAN	FAN 55*50*10 56MM 610	23.10044.001
Speake				
	NS	SPEAKER	SPEAKER MODULE-R 610	23.40056.001
		SPEAKER	SPEAKERMODULE-L610	23.40056.011

Picture	No.	Partname	Description	Part No.
Keyboard				
	15	KEYBOARD US	KB DFE/NSK-A4001 T2 610 US(84)	99.N2182.001
		KEYBOARD FRENCH	KB DFE/NSK-A400F T2 610 FRENC	99.N2182.00F
		KEYBOARD GERMAN	KB DFE/NSK-A400G T2 610 GERMAN	99.N2182.00G
		KEYBOARD JAPAN	KB DFE/NSK-A400J T2 610 JAPAN	99.N2182.00J
		KEYBOARD KOREA	KB DFE/NSK-A400K T2 610 KOREA	99.N2182.00K
		KEYBOARD SPANISH	KB DFE/NSK-A400S T2 610 SPANIS	99.N2182.00S
		KEYBOARD TAIWAN	KB DFE/NSK-A400T T2 610 TAIWAN	99.N2182.002
		KEYBOARD THAILAND	KB DFE/NSK-A4003 T2 610 THAI	99.N2182.003
Pointing Device				
	NS	TOUCHPAD	TOUCHPAD MULTI- SWITCH SYNAPTIC	56.1740C.001
		TOUCHPAD FRAME	610_TOUCHPAD_FRAME	41.41Q03.00
		TOUCHPAD BUTTON	610_TOUCHPAD_ BUTTON	42.41Q04.00
		TOUCHPAD FPC CABLE	610_TOUCHPAD_FPC	50.41Q05.00
		SCROLL KEY	610_SROLL_KEY	42.41Q03.00

Picture	No.	Partname	Description	Part No.
Wireless Communication Device				
	12	WIRELESS 802.11B ANTENNA LEFT	ANTENNA 802.11B(L)CZ2- A TM610	25.90013.031
	13	WIRELESS 802.11B ANTENNA RIGHT	ANTENNA 802.11B(R)CZ2-A TM610	25.90013.041
Cable				
	NS	POWER CORD 125V 3P	CORD 125V UL 3P K01081B1183WP	27.01618.051
		MICROPHONE CABLE	610_MIC_CABLE	50.41Q04.00
		MDC CABLE	C.A. MDC 2/2PIN 2CONN 85MM 610	50.41Q07.00
Main Board				
	5	MAINBOARD/TM610	T2-610 MB W/O CPU	55.41Q01.02
Board				
	NS	HDD BOARD	T2-610 HDD BD	55.41Q02.00
	NS	MODEM BOARD	MODEM MDC AMBIT/ U98M005.01	54.09011.301
	NS	PCI CARD 64BIT	PCI CARD 64BIT LUCENT/MPCI-101	54.03061.011

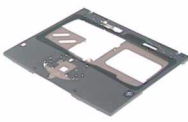
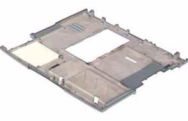
Picture	No.	Partname	Description	Part No.
Adapter				
	NS	ADT 60W 3P DELTA W/O POWER CORD	ADT 60W 90-264V ADP-60DB BB 3P	25.10064.191
		ADT 60W 3P LITEON W/O POWER CORD	ADT 3P PA-1600-02AE W/ ACER LOG	25.10068.111
Battery				
	23	BATTERY	ASSY BTY LI-ION 6CELL TM610	60.41Q15.00
	NS	BATTERY	ASSY BTYPACK PRIMARY 909-2140	60.41Q15.011
	NS	RTC BATTERY LI 3V	BTY LI 3V ML3032T6 65MAH TAPE	23.20004.111
Case/Cover/Bracket assembly				
	7	FRONT COVER	ASSYFRONT COVER610	60.41Q11.001
	8	HDD COVER	ASSY_HDD_BEZEL_610	60.41Q13.00
	3	UPPER CASE	UPPER_CASE_MODULE 610	60.41Q04.00
	4	LOWER CASE	LOWER_CASE_MODULE 610	60.41Q03.00
	NS	SMART CARD	ASSEMBLY SMART-CARD 610	60.41Q09.00
	NS	I/O BRACKET	ASSY_I/O_BRACKET_610	60.41Q19.00

Picture	No.	Partname	Description	Part No.
	NS	MIDDLE COVER	610_MIDDLE_COVER	42.41Q06.00
	NS	DIMM COVE	COVER DIM 610	34.41Q01.00
	NS	DUMMY PCMCIA	ARD DUMMY PCMCIA PA+ABS TM330	42.40C20.001
Miscellaneous				
	NS	PLATE NAME	PLATE NAME TM610(FOR 611TXR)	40.41Q12.011
		PLATE NAME	LBL NAME PLATE 51.7*6.7 610TXV	40.41Q12.00
Screws				
	26	SCREW	SCRW BIND M2*L3 B-ZN SHIVA	86.9A322.3R0
	27	SCREW	SCREW M2.5X6	86.9A353.6R0
	NS	HDD SCREW	SCREW M3*4L W/F NI	86.5A524.4R0
	NS	SCREW	SCREW FLAT M2*L6 BL-ZN	86.9A322.6R0
	NS	CPU THERMAL SCREW	SCREW SET CPU THERMAL 610	86.00938.220
	NS	SCREW	SCW HEX NYL I#R-40/ O#4-40 L5.5	34.00015.081

Model Definition and Configuration

TravelMate 610 Model Number Definitions

Model	LCD	CPU	Memory	Hard Disk Drive	CD/DVD-ROM	Floppy Disk Drive	Battery
610TXV	14.1" TFT	PIII-800MHz	128MB	20GB	8X DVD	External	Lilon
610TXVi	14.1" TFT	PIII-800MHz	128MB	20GB	8X DVD	External	Lilon
610TXR	14.1" TFT	PIII-800MHz	128MB	20GB	8/4/24 CD-RW	External	Lilon
610TXCi	14.1" TFT	PIII-800MHz	128MB	20GB	Combo(DVD+RW)	External	Lilon
611TXR	14.1" TFT	PIII-850MHz	128MB	20GB	8/4/24 CD-RW	External	Lilon
611TXRi	14.1" TFT	PIII-850MHz	128MB	20GB	8/4/24 CD-RW	External	Lilon
611TXC	14.1" TFT	PIII-850MHz	128MB	20GB	Combo(DVD+RW)	External	Lilon
611TXCi	14.1" TFT	PIII-850MHz	128MB	20GB	Combo(DVD+RW)	External	Lilon
612TXCi	14.1" TFT	PIII-900MHz	128MB	20GB	Combo(DVD+RW)	External	Lilon

Test Compatible Components

This computer's compatibility is tested and verified by Acer's internal testing department. All of its system functions are tested under Windows 98SE, Windows 2000 , and Windows ME environment.

Refer to the following lists for components, adapter cards, and peripherals which have passed these tests. Regarding configuration, combination and test procedures, please refer to the TravelMate 610 Compatibility Test Report released by the Acer Mobile SystemTesting Department.

Microsoft Windows 98 SE Environment Test

Item	Specifications
HDD	IBM 10G Hitachi 20G
Network Adapters	
LAN Ethernet/10baseT/100baseT	3Com Etherlink III TDK Ethernet PC Card LAN Adapter Xircom CreditCard Ethernet Adapter 10/100
Multi-Function Card	3Com 10/100 Fast EtherLink LAN+56K D-Link Winconnect 33.6 LAN/Fax modem combo
CardBus	3Com 10/100 LAN CardBus Intel EtherExpress PRO/100 Mobile Adapter TDK CardBus Ethernet 10/100 Base TX D-Link Fast Ethernet Cardbus 10/100Mbps IBM 10/100 EtherJet Cardbus Adapter (32-bit) Xircom Cardbus Ethernet 10/100 Intel Built-in LAN
Other	Lucent Wave LAN IEEE 802.11 PCMCIA Card Xircom Pocket Internet III
Memory Module	PSC 64MB Mitsubishi 64MB NEC 64 & 128 MB Winbond 64 & 128 MB Infineon 256 MB
Modem Adapter	
Modem (up to 56K)	Pretec Modem 56K ActionTec DataLink 56Kbps Fax/Mode TDK V.90/K56Kflex Data/Fax Mode Xircom CREDITCARD MODEM 56 USR Megahertz 56K mode
ISDN	USR Megahertz ISDN 128K IBM ISDN Internet PC Card
I/O Peripheral	
I/O Display	IBM 9514-B04 TFT Monito Acer TFT monitor NEC 20" Color Monitor Acer 211c ViewSonic PF790
I/O - Keyboard	Chicony Keyboard (USB) IBM Numeric Keyboard III IBM, US English KBD (PS/AT Style) Microsoft Natural KBD USB Acer 101 keyboard
I/O - Mous	IBM PS Style Mouse (Black) Microsoft IntelliMouse optical IBM ThinkPad Mobile Mouse Microsoft IntelliMouse Explorer Logitech MouseMan Wheel USB Comb for DOSV &iMac Logitech Serial Mouse

Item	Specifications
I/O - Parallel (Printer)	IBM Network Printer 17 CANON Color Bubble Jet BJC600 EPSON Stylus Color 740 HP DeskJet 880C printer (USB) HP LaserJet 6MP CANON USB Printer
I/O - Parallel (Scanner)	Acer AcerScan Prisa 620s
I/O - USB	Sanwa USB HUB (self-power) USB, USB HUB 4 PORTS TI-CHIPS EIZO I. Station USB HUB 3Com USB Network Interface Iomega USB ZIP250 ELECOM USB HUB 4-port
I/O - USB Modem	Best Data USB 56K V.90 Modem Speakerphone BLASTER USB BLASTER Modem 56K V.90
I/O - USB (Joystick)	USB Rockfire Avant Garde Flightstick Microsoft SIDEWINDER Precision PRO (USB)
I/O - USB Camera	Acer USB Video capture Kit Intel Digital Camera Kodak DVC 300 (Digital-Video-Camera) IBM, IBM PC Camera
I/O Adapter	
PCMCIA - SCSI	Adaptec 1480A slim SCSI CB Adaptec SlimSCSIAPA-1460AB NewMedia BUSToaster PCMCIA to SCSI
PCMCIA - CDROM	Panasonic 20x Portable CD-ROM Playe
PCMCIA - ATA	Sundisk ATA 15MB IBM Travel Kit 340MB microdrive IBM 340MB MicroDrive + PC Card Adapter SONY Memory Stick (64MB + PC Card Adapter) EPSON Flash Packer 6M
PCMCIA - Other	IBM Portable Drive Bay Melco IEEE1394 interface PCMCIA Card Lacie, LACIE IEEE 1394 (Fire Wire) Hard Drive Sony DCR TRV-10/ACCKit M90 (1394 Camera) w/ video capture PC card DVBK-CW200 BUFFALO IEEE 1394 interface IFC-ILCB/DV Cardbus
PCMCIA	
USB Device	Nokia Cellular Data Suite 1.2 (support IR) w/ 6150 Nokia Card Phone Nokia Cellular Data Card (PCMCIA) w/ 8110 or 6150 Ericsson, Mobile Office DC23 w/ PH38 Ericsson, Mobile Office D127 w/ GF768

Microsoft Windows 2000 Environment Test

Item	Specifications
HDD	IBM 10G & 20G Hitachi 10G & 20G
Network Adapters	
LAN Ethernet/10baseT/100baseT	3Com Etherlink III 3Com 10/100 16 bits Fast Etherlink D-link Ethernet TDK Ethernet PC card LAN adapte Xircom CreditCard Ethernet Adapter IIps Xircom CreditCard Ethernet Adapter 10/100
LAN Token Ring	Madge Smart 16/4 RingNode MK2 @ IBM Turbo 16/4 TokenRing PC Card
Multi-Function Card	D-Link Winconnect 33.6 LAN/Fax modem combo Xircom Credit Card Ethernet 10/100 + Modem 56
CardBus	3Com 10/100 LAN CardBus Intel EtherExpress PRO/100 Mobile Adapter TDK CardBus Ethernet 10/100 Base TX D-Link Fast Ethernet Cardbus 10/100Mbps IBM 10/100 EtherJet Cardbus Adapter (32-bit) Xircom Cardbus Ethernet 10/100 Intel Built-in LAN
Other	Lucent Wave LAN IEEE 802.11PCMCIA Card
Memory Module	PSC 64MB Mitsubishi 64MB NEC 64 & 128 MB Winbond 64 & 128 MB Infineon 256 MB
Modem Adapter	
Modem (up to 56K)	Pretec Modem 56K ActionTec DataLink 56Kbps Fax/Mode TDK V.90/K56Kflex Data/Fax Mode Xircom CREDITCARD MODEM 56 USR Megahertz 56K mode
ISDN	USR Megahertz ISDN 128K
I/O Peripheral	
I/O Display	IBM 9514-B04 TFT Monito Acer TFT monitor NEC 20" Color Monitor Acer 211c ViewSonic PF790
I/O - Keyboard	Chicony Keyboard (USB) IBM Numeric Keypad III Compaq, Compaq Keyboard IBM, US English KBD (PS/AT Style) Microsoft Natural KBD USB Acer 101 keyboard

Item	Specifications
I/O - Mous	IBM PS Style Mouse (Black) Logitech USB Wheel Mouse Acer Aspire USB mouse (USB) Fu Hwa USB mouse (USB) Microsoft IntelliMouse optical Logitech PS Style Mouse Microsoft Inteli Mouse USB IBM ThinkPad Mobile Mouse Microsoft IntelliMouse Explorer Logitech MouseMan Wheel USB Comb for DOSV &iMac
I/O - Parallel (Printer)	IBM Network Printer 17 CANON Color Bubble Jet BJC600 EPSON Stylus Color 740 HP DeskJet 880C printer (USB) HP LaserJet 6MP CANON USB Printer
I/O - Parallel (Scanner)	Acer AcerScan Prisa 620s
I/O - USB	Sanwa USB HUB (self-power) USB, USB HUB 4 PORTS TI-CHIPS EIZO I. Station USB HUB 3Com USB Network Interface Iomega USB ZIP250 ELECOM USB HUB 4-port
I/O - USB Modem	Best Data USB 56K V.90 Modem Speakerphone BLASTER USB BLASTER Modem 56K V.90
I/O - USB (Speaker	JS USB Digital Speakers Panasonic USB Speaker AIWA MultiMedia Digital Speaker System (USB)
I/O - USB (Joystick)	USB Rockfire Avant Garde Flightstick Microsoft SIDEWINDER Precision PRO (USB)
I/O - USB Camera	Acer USB Video capture kit Kodak DVC 300 (Digital-Video-Camera)
I/O Adapter	
PCMCIA - SCSI	Adaptec 1480A slim SCSI CB Adaptec SlimSCSI APA-1460AB NewMedia BUSToaster PCMCIA to SCSI
PCMCIA - CDROM	Panasonic 20x Portable CD-ROM Playe
PCMCIA - ATA	Sundisk ATA 15MB IBM Travel Kit 340MB microdrive IBM 340MB MicroDrive + PC Card Adapter SONY Memory Stick (64MB) + PC Card Adapter EPSON Flash Packer 6M
PCMCIA - Other	IBM Portable Drive Bay Melco IEEE 1394 interface PCMCIA Card LACIE IEEE 1394 (Fire Wire) Hard Drive Sony - DCR TRV - 10/ACCKIT M90 (1394 Camera) with Video Capture PC card DVBK-CW200 BUFFALO IEEE 1394 interface IFC-ILCB/DV Cardbus
PCMCIA	

Item	Specifications
USB Device	Nokia Cellular Data Suite 1.2 (support IR) w/ 6150 Nokia Card Phone Nokia Cellular Data Card (PCMCIA) w/ 8110 or 6150 Motorola, Digital Cellular Fax and Data Modem CELLect 3 GSM/ DCS1800 w/ cd928+ Ericsson, Mobile Office DC23 w/ PH38 Ericsson Mobile Office DI27 w/ GF768

Windows ME Environment Test

Item	Specifications
HDD	IBM 10G & 20G Hitachi 10G & 20G
Network Adapters	
LAN Ethernet/10baseT/100baseT	3Com Etherlink III 3Com 10/100 16bits Fast Etherlink D-Link Ethernet TDK Ethernet PC Card LAN adapter IBM EtherJet PC Card Xircom Credit Card Ethernet Adapter IIps Xircom CreditCard Ethernet Adapter 10/100
LAN Token Ring	Madge Smart 16/4 RingNode MK2@ IBM Turbo 16/4 TokenRing PC Card
Multi-Function Card	3Com 10/100 Fast EtherLink LAN+56K D-Link Winconnect 33.6 LAN/Fax modem combo Xircom CreditCard Ethernet 10/100 + Modem 5
CardBus	3Com 10/100 LAN CardBus Intel EtherExpress PRO/100 Mobile Adapter TDK CardBus Ethernet 10/100 Base TX D-Link Fast Ethernet Cardbus 10/100mbps IBM 10/100 EtherJet Cardbus Adapter (32-bit) Xircom Cardbus Ethernet 10/100 Intel Built-in LAN
Other	Xircom pocket Ethernet III
Memory Module	PSC 64MB Mitsubishi 64MB NEC 64 & 128 MB Winbond 64 & 128 MB Infineon 256 MB
Modem Adapter	
Modem (up to 56K)	Pretec Modem 56K ActionTec DataLink 56Kbps Fax/Mode TDK V.90/K56Kflex Data/Fax Mode Xircom CREDITCARD MODEM 56 USR Megahertz 56K mode
ISDN	USR Megahertz ISDN 128K IBM ISDN Internet PC Card
I/O Peripheral	
I/O Display	IBM 9514-B04 TFT Monito Acer TFT monitor NEC 20" Color Monitor Acer 211c ViewSonic PF790
I/O - Keyboard	Chicony Keyboard (USB) Compaq, Compaq Keyboard IBM US English KBD (PS/AT Style) Microsoft Natural KBD USB Acer 101 keyboard

Item	Specifications
I/O - Mous	IBM PS Style Mouse (Black) Logitech USB Wheel Mouse Acer Aspire USB mouse (USB) Fu Hwa USB mouse Microsoft IntelliMouse optical Logitech PS Style Mouse Microsoft Inteli Mouse USB IBM ThinkPad Mobile Mouse Microsoft Intelli Mouse Explore Logitech Serial mouse
I/O - Parallel (Printer)	IBM Network Printer 17 CANON Color Bubble Jet BJC600 EPSON Stylus Color 740 HP DeskJet 880C printer (USB) HP LaserJet 6MP CANON USB Printer
I/O - Parallel (Scanner)	Acer AcerScan Prisa 620s
I/O - USB	Sanwa USB HUB (self-power) USB, USB HUB 4 PORTS TI-CHIPS EIZO I. Station USB HUB 3Com USB Network Interface Iomega USB ZIP250 ELECOM USB HUB 4-port
I/O - USB Modem	BLASTER USB BLASTER Modem 56K V.90
I/O - USB (Speaker)	JS USB Digital Speaker AIWA MultiMedia Digital Speaker System (USB)
I/O - USB (Joystick)	USB Rockfire Avant Garde Flightstick Microsoft SIDEWINDER Precision PRO (USB)
I/O - USB Camera	Acer Video Capture Kit Intel Digital Camera Kodak DVC 300 (Digital-Video-Camera) IBM, IBM PC Camera
I/O Adapter	
PCMCIA - SCSI	Adaptec 1480A slim SCSI CB Adaptec SlimSCSI APA-1460AB NewMedia BUSToaster PCMCIA to SCSI
PCMCIA - CDROM	Panasonic 20x Portable CD-ROM Playe
PCMCIA - ATA	Sundisk ATA 15MB IBM Travel Kit 340MB microdrive IBM 340MB MicroDrive + PC Card Adapter SONY Memory Stick (64MB) + PC Card Adapter EPSON Flash Packer 6M
PCMCIA - Other	IBM Portable Drive Bay IEEE1394 interface PCMCIA Card Lacie, LACIE IEEE1394 (Fire Wire) Hard Drive Sony - DCR TRV - 10/ACCKIT M90 (1394 Camera) with Video Capture PC card DVBK-CW200 BUFFALO IEEE 1394 interface IFC-ILCB/DV Cardbus

Item	Specifications
PCMCIA	<p data-bbox="151 183 1230 409">USB Device</p> <p data-bbox="529 183 1230 409">Nokia Cellular Data Suite 1.2 (support IR) w/ 6150 Nokia Card Phone Nokia Cellular Data Card (PCMCIA) w/ 8110 or 6150 Motorola, Digital Cellular Fax and Data Modem CELLect 3 GSM/ DCS1800 w/ cd928+ Ericsson, Mobile Office DC23 w/ PH38 Ericsson Mobile Office DI27 w/ GF768</p>

Online Support Information

This section describes online technical support services available to help you repair your Acer Systems.

If you are a distributor, dealer, ASP or TPM, please refer your technical queries to your local Acer branch office. Acer Branch Offices and Regional Business Units may access our website. However some information sources will require a user i.d. and password. These can be obtained directly from AcerCSD Taiwan.

Acer's Website offers you convenient and valuable support resources whenever you need them.

In the Technical Information section you can download information on all of Acer's Notebook, Desktop and Server models including:

- q Service guides for all models
- q User's manuals
- q Training materials
- q Main manuals
- q Bios updates
- q Software utilities
- q Schematics
- q Spare parts lists
- q Chips
- q TABs (Technical Announcement Bulletin)

The service repair section provides you with downloadable information on:

- q Troubleshooting guides
- q Tooling box information
- q Repair instructions for specific models
- q Basic repair guidelines
- q Debug cards for Acer's latest models

For these purposes, we have included an Acrobat File to facilitate the problem-free downloading of our technical material.

Also contained on this website are:

- q Detailed information on Acer's International Traveller's Warranty (ITW)
- q Returned material authorization procedures
- q An overview of all the support services we offer, accompanied by a list of telephone, fax and email contacts for all your technical queries.

We are always looking for ways to optimize and improve our services, so if you have any suggestions or comments, please do not hesitate to communicate these to us.

A

AC Adapter 23
 AFLASH Utility 39
 Audio 19
 Auxiliary Input Device Check 76

B

Battery 22
 Battery Pack
 Removing 51
 BIOS 16
 BIOS Setup Utility 29
 BIOS Utility 29–??
 Basic System Settings 31
 Navigating 29
 Onboard Device Configuration 34
 Startup Configuration 32
 System Information 30
 System Security 36
 Block Diagram 3
 Board Layout 4
 Bottom View 5
 Top View 4

C

Check Procedures 76
 Battery 77
 Diskette Drive 76
 External CD-ROM Drive 76
 Keyboard 76
 Memory 77
 Power Adapter 77
 Power System Checkout 77
 Touchpad 78
 Connectors 89

D

DC-AC LCD Inverter 22

Disassembly Procedure Flowchart 49
 DMA Channel Assignment 27

E

Environmental Requirements 25
 Error Messages 80
 Error Symptoms 82
 Indicator 82
 LCD 82
 Memory 83
 PCMCIA 83
 Power 82
 Power Management 83
 Speaker 83
 Error Symptom-to-Spare Part Index 79
 ESD 24
 Extended Memory
 removing 55
 External Diskette Drive Check 76

F

Features
 Connectivity 1
 Display 2
 Expansion 2
 Human-centric Design and Ergonomics 2
 Performance 1
 Flash Utility 39
 FRU 95

H

Hard disk drive
 disassembling 52
 Hardware Specifications and Configurations 16

I

I/O Address Map 26
 I/O Ports 25
 Indicators 11

Intermittent Problems 86

Inverter Board
removing 60

IrDA Port 21

IRQ Assignment Map 26

J

Jumpers 89
Bottom View 91
Top View 89

K

Keyboard 12, 22
removing 58
Keyboard Device Check 76

L

LCD 23
disassembly 57

M

Machine Disassembly and Replacement 47
Main board
removing 71
Memory 17
Memory Address Map 25
Memory Check 77
Middle Cover
removing 57
Model Definition and Configuration 107

O

Online Support Information 119
OVP 23

P

Panel 6
Bottom Panel 10
Front Panel 6
Left Panel 7
Rear Panel 9
Right Panel 8
PCB 99203 89

PCMCIA Port 21

POST 79

Power Management

Display Standby Mode 24
Hard Disk Standby Mode 24
Hibernation Mode 24
Standby Mode 24

Power System Check 77

Battery Pack 77
Power Adapter 77

Power System Checkout 77

PQA 42

Processor 16

R

RMA 95

S

Screw List 50
System Check Procedures 76
System Specifications 1
Features 1
System Utilities 29
System Utility Diskette 40

T

Test Compatible Components 109
Touchpad Check 78
Troubleshooting 75

U

Undetermined Problems 86
Upper Case
removing 64
USB Port 21
utility
BIOS 29-??

V

Video Resolutions Mode 21

W

Windows 2000 Environment Test 112

Windows 98 EnvironmentTest 110

Windows Millenium EnvironmentTest 115

